

# GUIDELINES FOR ENVIRONMENTALLY SOUND MANAGEMENT OF E-WASTE

(As approved vide MoEF letter No.  
23-23/2007-HSMD dt. March 12, 2008)



सत्यमेव जयते



जहाँ है हरियाली ।  
वहाँ है खुशहाली ॥



MINISTRY OF ENVIRONMENT & FORESTS  
CENTRAL POLLUTION CONTROL BOARD  
Delhi

MARCH, 2008

## EXECUTIVE SUMMARY

The electrical and electronic waste (e-waste) is one of the fastest growing waste streams in the world. The increasing “market penetration” in developing countries, “replacement market” in developed countries and “high obsolescence rate” make e-waste as one of the fastest growing waste streams. Environmental issues and trade associated with e-waste at local, transboundary and international level has driven many countries to introduce interventions.

In accordance with the National Environmental Policy (NEP) and to address sustainable development concerns, there is a need to facilitate the recovery and/or reuse of useful materials from waste generated from a process and/or from the use of any material thereby, reducing the wastes destined for final disposal and to ensure the environmentally sound management of all materials. The NEP also encourages giving legal recognition and strengthening the informal sectors system for collection and recycling of various materials. In particular considering the high recyclable potential of e-waste such wastes should be subject to recycling in an environmentally sound manner.

E-waste comprises of wastes generated from used electronic devices and household appliances which are not fit for their original intended use and are destined for recovery, recycling or disposal. Such wastes encompasses wide range of electrical and electronic devices such as computers, hand held cellular phones, personal stereos, including large household appliances such as refrigerators, air conditioners etc. E-wastes contain over 1000 different substances many of which are toxic and potentially hazardous to environment and human health, if these are not handled in an environmentally sound manner.

The growth of e-waste has significant economic and social impacts. The increase of electrical and electronic products, consumption rates and higher obsolescence rate leads to higher generation of e-waste. The increasing obsolescence rate of electronic products also adds to the huge import of used electronics products. The e-waste inventory based on this obsolescence rate in India for the year 2005 has been estimated to be 1,46,180 tonnes which is expected to exceed 8,00,000 tonnes by 2012.

The objective of these Guidelines is to provide guidance for identification of various sources of waste electrical and electronic equipments (e-waste) and prescribed procedures for handling e-waste in an environmentally sound manner.

These Guidelines shall apply to all those who handle e-waste which includes the generators, collectors, transporters, dismantlers, recyclers and stakeholders of e-wastes irrespective of their scale of operation.

In India, there are no specific environmental laws or Guidelines for e-waste. None of the existing environmental laws have any direct reference to electronic

waste or refer to its handling as hazardous in nature. However several provisions of these laws may apply to various aspects of electronic wastes. Since e-waste or its constituents fall under the category of 'hazardous' and "non hazardous waste", they shall be covered under the purview of "The Hazardous Waste Management Rules, 2003".

Composition of e-waste is very diverse and differs in products across different categories. Broadly, it consists of ferrous and non-ferrous metals, plastics, glass, wood & plywood, printed circuit boards, concrete and ceramics, rubber and other items. Iron and steel constitutes about 50% of the e-waste followed by plastics (21%), non ferrous metals (13%) and other constituents. Non-ferrous metals consist of metals like copper, aluminium and precious metals ex. silver, gold, platinum, palladium etc. The presence of elements like lead, mercury, arsenic, cadmium, selenium, and hexavalent chromium and flame retardants beyond threshold quantities in e-waste classifies them as hazardous waste.

The e-waste inventory based on this obsolescence rate and installed base in India for the year 2005 has been estimated to be 146180.00 tonnes. This is expected to exceed 8,00,000 tonnes by 2012. There is a lack of authentic and comprehensive data on e-waste availability for domestic generation of e-waste and the various State Pollution Control Boards have initiated the exercise to collect data on e-waste generation.

Sixty-five cities in India generate more than 60% of the total e-waste generated in India. Ten states generate 70% of the total e-waste generated in India. Maharashtra ranks first followed by Tamil Nadu, Andhra Pradesh, Uttar Pradesh, West Bengal, Delhi, Karnataka, Gujarat, Madhya Pradesh and Punjab in the list of e-waste generating states in India. Among top ten cities generating e-waste, Mumbai ranks first followed by Delhi, Bangalore, Chennai, Kolkata, Ahmedabad, Hyderabad, Pune, Surat and Nagpur.

Under Rule 3, "Definitions", E-waste can be defined as "Waste Electrical and Electronic Equipment including all components, sub assemblies and their fractions except batteries falling under Schedule 1, Schedule 2 and Schedule 3" of these rules.

There is an increasing trend in the reduction in the use of hazardous substances such as lead, cadmium, mercury, polychlorinated biphenyls (pcbs) and other toxic and hazardous substances for which safe substitutes have been found. Many countries have adopted the RoHS regulations in the manufacture of electrical and electronic equipments.

The Extended Producer Responsibility (EPR) is an environment protection strategy that makes the producer responsible for the entire life cycle of the product, especially for take back, recycle and final disposal of the product. Thus the producers' responsibility is extended to the post-consumer stage of the product life cycle. This needs to be included in the legislative framework making

EPR a mandatory activity associated with the production of electronic and electrical equipments over a period of time.

Environmentally sound E-waste treatment technology was identified at three levels. The first level included decontamination, dismantling and segregation. The second level included shredding and four special treatment processes like electromagnetic separation, eddy current separation, CRT breaking and treatment and density separation using water. The 3<sup>rd</sup> level treatment included recovery of metals and disposal of hazardous E-waste fractions including plastics with flame retardants, CFCs, capacitors, Mercury, lead and other items.

All the three levels of e-waste treatment are based on material flow. The material flows from 1<sup>st</sup> level to 3<sup>rd</sup> level treatment. Each level treatment consists of unit operations, where e-waste is treated and out put of 1st level treatment serves as input to 2<sup>nd</sup> level treatment. After the third level treatment, the residues are disposed of either in TSDF or incinerated. The efficiency of operations at first and second level determines the quantity of residues going to TSDF or incineration. The details of the type of treatment technology to be put in place are given in Chapter – VI.

The establishment of E-waste Recycling & Treatment Facility shall be in line with the existing Guidelines/best practices/requirements in India for establishing and operating “Recycling and Treatment and Disposal Facilities” for hazardous wastes. Such facilities shall be set up in the organized sector. However, the activities presently operating in the informal sector need to be upgraded to provide a support system for the integrated facility. This would enable to bring the non-formal sector in the main stream of the activity and facilitate to ensure environmental compliances.

The procedures for setting up & management of e-waste facility shall include licenses from all appropriate governing authorities such as environmental clearance, recycler registration from Central Pollution Control Board under HW Rules, obtaining of consents under water act, Air act and authorization from the state pollution control board.

These Guidelines are reference document for the management, handling and disposal of e-wastes. These are intended to provide guidance and broad outline, however, the specific methods of treatment and disposal for specific wastes needs to be worked out according to the hazard/risk potential of the waste under question. These Guidelines provide the minimum practice required to be followed in the management of e-wastes and the *State Department of Environment or State Pollution Control Board* may prescribe more stringent norms as deemed necessary.



## TABLE OF CONTENTS

<b>EXECUTIVE SUMMARY</b>		
<b>Chapter 1</b>	<b>INTRODUCTION</b>	
1.0	Preamble	01
1.1	E-Waste	01
1.2	Environmentally Sound Management of E-waste	01
<b>Chapter 2</b>	<b>OBJECTIVE &amp; SCOPE OF THE GUIDELINES</b>	
2.1	Objective	02
2.2	Scope	02
2.3	Applicability	02
2.4	Need for the Guidelines for Environmentally Sound Management	03
<b>Chapter 3</b>	<b>REGULATORY REGIME FOR E-WASTE</b>	
3.1	The Hazardous Wastes (Management and Handling) Rules, 2003	04
3.2	The Municipal Solid Wastes (Management and Handling) Rules, 2000	07
3.3	Basel Convention	08
<b>Chapter 4</b>	<b>CLASSIFICATION OF E-WASTE</b>	
4.0	Composition of E-Waste	09
4.1	Components of E-Waste	09
4.2	Possible hazardous substances present in e-waste	12
4.3	E-waste scenario	16
4.4	Basis for Defining e-waste	17
4.5	Proposed definition of E-Waste	18
4.6	Reduction of the Hazardous Substances (RoHS) in the Electronic & electrical Equipments	19
4.7	Extended Producer Responsibility (EPR)	19
<b>Chapter 5</b>	<b>GUIDELINES FOR ENVIRONMENTALLY SOUND MANAGEMENT FOR E-WASTE</b>	
5.1	E-waste Composition and Recycle Potential	21
5.2	Assessment of Hazardousness of e-waste	21
5.3	Recycling, Reuse and Recovery Options	25
5.4	Treatment & Disposal Options	25
5.5	E-waste Recycling/Treatment technologies in India	27

<b>Chapter 6</b>	<b>ENVIRONMENTALLY SOUND TREATMENT TECHNOLOGY FOR E-WASTE</b>	
6.1	Environmentally sound E-waste treatment technologies	28
6.2	Environmental Impacts of the 1 <sup>st</sup> , 2 <sup>nd</sup> and 3 <sup>rd</sup> level e-waste treatment system	42
6.3	Technology Currently Used in India	43
6.4	Best Available Technology	44
6.5	Available Operating Facilities	45
<b>Chapter 7</b>	<b>GUIDELINES FOR ESTABLISHMENT OF INTEGRATED E-WASTE RECYCLING &amp; TREATMENT FACILITY</b>	
7.1	Facility Operation Requirements	47
7.2	Procedures for Setting-up & Management of integrated e-waste facility	51
7.3	Procedures for compliance with the existing regulations and Guidelines	52
<b>Annexure – I</b>	International Scenario	55
<b>Annexure – II</b>	Hazardous Substances that can occur in e-waste	64
<b>Annexure – III</b>	Average weight and composition of selected appliances (typical)	71
<b>Annexure – IV</b>	Recoverable quantity of elements in a PC (typical)	72
<b>Annexure – V</b>	Recoverable quantity of elements in a TV (typical)	73
<b>Annexure – VI</b>	Materials recovered from refrigerators (typical)	74
<b>Annexure – VII</b>	Comparison of thresholds	75
<b>Annexure – VIII</b>	E-waste trade value chain	80
<b>Annexure – IX</b>	Environmentally Sound Treatment (EST) schemes for E-waste	81
<b>Annexure – X</b>	Environmental impacts of the WEEE recycling system	82
<b>Annexure – XI</b>	Process flow diagram of an integrated facility	83
<b>Appendix - 1</b>	REFERENCES	86

# CHAPTER 1

## INTRODUCTION

### 1.0 Preamble

The electrical and electronic waste (e-waste) is one of the fastest growing waste streams in the world. The increasing “market penetration” in developing countries, “replacement market” in developed countries and “high obsolescence rate” make e-waste as one of the fastest growing waste streams. Environmental issues and trade associated with e-waste at local, transboundary and international level has driven many countries to introduce interventions.

In accordance with the National Environmental Policy (NEP) and to address sustainable development concerns, there is a need to facilitate the recovery and/or reuse of useful materials from waste generated from a process and/or from the use of any material thereby, reducing the wastes destined for final disposal and to ensure the environmentally sound management of all materials. The NEP also encourages giving legal recognition and strengthening the informal sectors system for collection and recycling of various materials. In particular considering the high recyclable potential of e-waste such wastes should be subject to recycling in an environmentally sound manner.

### 1.1 E-waste

E-waste comprises of wastes generated from used electronic devices and house hold appliances which are not fit for their original intended use and are destined for recovery, recycling or disposal. Such wastes encompasses wide range of electrical and electronic devices such as computers, hand held cellular phones, personal stereos, including large household appliances such as refrigerators, air conditioners etc. E-wastes contain over 1000 different substances many of which are toxic and potentially hazardous to environment and human health, if these are not handled in an environmentally sound manner.

### 1.2 Environmentally Sound Management of E-waste

The growth of e-waste has significant economic and social impacts. The increase of electrical and electronic products, consumption rates and higher obsolescence rate leads to higher generation of e-waste. The increasing obsolescence rate of electronic products also adds to the huge import of used electronics products. The e-waste inventory based on this obsolescence rate in India for the year 2005 has been estimated to be 146180.00 tonnes which is expected to exceed 8,00,000 tonnes by 2012. There is no large scale organized e-waste recycling facility in India and there are two small e-waste dismantling facilities are functioning in Chennai and Bangalore, while most of the e-waste recycling units are operating in un-organized sector.

## Chapter 2

### OBJECTIVE & SCOPE OF THE GUIDELINES

#### 2.1 Objective

The objective of these Guidelines is to provide guidance for identification of various sources of waste electrical and electronic equipments (e-waste) and prescribed procedures for handling e-waste in an environmentally sound manner.

#### 2.2 Scope

These Guidelines are reference document for the management, handling and disposal of e-wastes. These are intended to provide guidance and broad outline, however, the specific methods of treatment and disposal for specific wastes needs to be worked out according to the hazard/risk potential of the waste under question. These Guidelines provide the minimum practice required to be followed in the management of e-wastes and the *State Department of Environment or State Pollution Control Board* may prescribe more stringent norms as deemed necessary.

#### 2.3 Applicability

These Guidelines shall apply to all those who handle e-waste which includes the generators, collectors, transporters, dismantlers, recyclers and stakeholders of e-wastes irrespective of their scale of operation. The definitions in Hazardous Wastes (Management and Handling) Rules, 1989 as amended in 2003 include:

- (i) “occupier” in relation to any factory or premises, means a person who has, control over the affairs of the factory or the premises and includes in relation of any substance, the person in possession of the substance;
- (ii) “operator of facility” means a person who owns or operates a facility for collection, reception, treatment, storage or disposal of hazardous wastes;
- (iii) “recycler” means an occupier who procures and processes hazardous materials for recovery;
- (iv) “recycling” means reclamation and reprocessing of hazardous materials from a production process in an environmentally sound manner for the original purpose or for other purposes.
- (v) “reuse” means hazardous materials that are used for the purpose for its original use or another use.
- (vi) “registered recycler or re-refiner or reuser” means a recycler or re-refiner or reuser registered for reprocessing hazardous material with the Central Government in the Ministry of Environment and Forests or the Central Pollution Control Board, as the case may be, for recycling or reprocessing hazardous materials;



- (vii) “recovery” means to any operation in the recycling activity wherein specific materials are recovered;

## **2.4 Need for the Guidelines for Environmentally Sound Management**

Based on the outcome of the studies carried out and the consensus arrived at the National Workshop on electronic waste management held in March 2004 and June 2005 organised by CPCB and Ministry of Environment & Forests an assessment was made of the existing practice in the e-waste management.

### **(a) *Increasing amount of E- Waste:***

Product obsolescence is becoming more rapid since the speed of innovation and the dynamism of product manufacturing / marketing has resulted in a short life span (less than two years) for many computer products. Short product life span coupled with exponential increase at an average 15% per year will result in doubling of the volume of e-waste over the next five to six years.

### **(b) *Toxic components:***

E-waste are known to contain certain toxic constituents in their components such as lead, cadmium, mercury, polychlorinated bi-phenyls (PCBs), etched chemicals, brominated flame retardants etc., which are required to be handled safely. The recycling practices were found to more in informal sectors leading to uncontrolled release of toxic materials into the environment as a result of improper handling of such materials.

### **(c) *Lack of environmentally sound recycling infrastructure:***

It has been established that e-waste, in the absence of proper disposal, find their way to scrap dealers, which are further pushed into dismantler's, supply chain. Existing environmentally sound recycling infrastructure in place is not equipped to handle the increasing amounts of e-waste. The major dismantling operations are occurring in unorganized/informal sector in hazardous manner. The potential of increased e-waste generation and lack of adequate recycling facilities have attracted the attention of a number of recyclers globally, expressing interest to start recycling facility in India.

## CHAPTER 3

### REGULATORY REGIME FOR E-WASTE

In India, there are no specific environmental laws or Guidelines for e-waste. None of the existing environmental laws have any direct reference to electronic waste or refer to its handling as hazardous in nature. However several provisions of these laws may apply to various aspects of electronic wastes. Since e-waste or its constituents fall under the category of ‘hazardous’ and “non hazardous waste”, they shall be covered under the purview of “The Hazardous Waste Management Rules, 2003”. Respective definitions, their meaning and interpretation under the rule is given below.

#### 3.1 The Hazardous Wastes (Management and Handling) Rules, 2003

The Hazardous Waste (Management and handling) Rule, 2003, defines “**hazardous waste**” as any waste which by reason of any of its physical, chemical, reactive, toxic, flammable, explosive or corrosive characteristics causes danger or likely to cause danger to health or environment, whether alone or when on contact with other wastes or substances, and shall include:

- Waste substances that are generated in the 36 processes indicated in column 2 of Schedule 1 and consist of wholly or partly of the waste substances referred to in column 3 of same schedule.
- Waste substances that consist wholly or partly of substances indicated in five risks class (A,B,C,D,E) mentioned in Schedule 2, unless the concentration of substances is less than the limit indicated in the same Schedule.
- Waste substances that are indicated in Lists A and B of Schedule 3 (Part A) applicable only in cases of import and export of hazardous wastes in accordance with rules 12, 13 and 14 if they possess any of the hazardous characteristics listed in Part B of schedule 3.

“**Disposal**” means deposit, treatment, recycling and recovery of any hazardous wastes.

Important features of Schedule 1, 2 and 3, which may cover E-waste are given below.

#### Schedule 1

Although, there is no direct reference of electronic waste in any column of Schedule 1 (which defines hazardous waste generated through different industrial processes), the “disposal process” of e-waste could be characterized as hazardous processes. The indicative list of these processes is given below.

- Secondary production and/ or use of Zinc
- Secondary production of copper
- Secondary production of lead
- Production and/ or use of cadmium and arsenic and their compounds
- Production of primary and secondary aluminum
- Production of iron and steel including other ferrous alloys (electric furnaces, steel rolling and finishing mills, coke oven and by product plan)
- Production or industrial use of materials made with organo silicon compounds
- Electronic industry
- Waste treatment processes, e.g. incineration, distillation, separation and concentration techniques

As per these regulations, once a waste product is classified as hazardous according to industrial process listed in Schedule 1, it is exempted from the concentration limit requirement set by Schedule 2 of Act, and is considered hazardous irrespective of its concentrations.

## **Schedule 2**

The Schedule 2 of the Hazardous Waste Management and Handling Rules 2003, lists waste substances which should be considered hazardous unless their concentration is less than the limit indicated in the said Schedule. The various classes of substances listed in this Schedule relevant to E-waste are covered in Class A, B, C, D and E are given below. E-waste or its fractions coming broadly under Class A and B are given below.

### **Class A: Concentration Limit: $\geq 50$ mg/kg**

The indicative waste list, which could be part of E-waste or its fractions under this class are given below.

- Antimony and antimony compounds
- Beryllium and beryllium compounds
- Cadmium and cadmium compounds
- Chromium (VI) compounds
- Mercury and mercury compounds
- Halogenated compounds of aromatic rings, e.g. polychlorinated biphenyls, polychloroteriphenyls and their derivatives
- Halogenated aromatic compounds

## **Class B: Concentration Limit: $\geq$ 5,000 mg/kg**

The indicative waste list, which could be part of E-waste or its fractions under this class are given below.

- Cobalt compounds
- Copper compounds
- Lead and lead compounds
- Nickel compounds
- Inorganic tin compounds
- Vanadium compounds
- Tungsten compounds
- Silver compounds
- Halogenated aliphatic compounds
- Phenol and phenolic compounds
- Chlorine
- Bromine
- Halogen-containing compounds, which produce acidic vapors on contact with humid air or water

### **Schedule 3**

List of Hazardous Waste to be applicable only for imports and exports are mentioned in schedule 3. It define hazardous waste as “Wastes listed in lists ‘A ’ and ‘B ’ of part A of schedule 3 applicable only in case(s)of export/import of hazardous wastes in accordance with rule 12, 13, and 14 only if they possess any of the hazardous characteristics in part B of said schedule”. This clause defines hazardous waste for the purpose of import and export. It has divided hazardous waste into two parts, A and B. Part A of the schedule deals with two lists of waste to be applicable only for imports and exports purpose. Export and import of items listed in List A and B of part A are permitted only as raw materials for recycling or reuse.

#### ***Electronic Waste and Related Items listed in part A, Lists of wastes applicable for Import and Export***

Following are the electronic items being mentioned in list A:

- A1180 “Electrical and electronic assemblies or scraps containing components such as accumulators and other batteries included on list B, mercury-switches, glass from cathode ray tubes and other activated glass and PCB-capacitors, or contaminated with schedule 2 constituents (e.g. cadmium, mercury, lead, polychlorinated biphenyl)to an extent that they exhibit hazard characteristics indicated in part B of this schedule (see B1110)”.

A1090	Ashes from the incineration of insulated copper wire.
A1150	Precious metal ash from incineration of PCBs not included on list 'B'
A2010	Glass waste from cathode ray tubes and other activated glass.
A3180	Wastes, substances and articles containing, consisting of or contaminated with polychlorinated biphenyls (PCB) and including any other poly brominated analogues of these compounds, at a concentration level of 50 mg/kg or more.

Following are electronic items placed on list B B1110:

1. Electronic assemblies consisting only of metals or alloys
2. Waste Electrical and electronic assemblies scrap (including printed circuit board, electronic components and wires) destined for direct reuse and not for recycling or final disposal.
3. Waste electrical and electronic assemblies scrap (including printed circuit boards) not containing components such as accumulators and other batteries included on list A, mercury switches, glass from cathode ray tubes and other activated glass and PCB- capacitors, or not contaminated with constituents such as cadmium, mercury, lead, polychlorinated biphenyl) or from which these have been removed, to an extent that they do not possess any of the constituents mentioned in Schedule 2 to the extent of concentration limits specified therein.
4. Electrical and electronic assemblies (including printed circuit boards, electronic components and wires) destined for direct reuse and not for recycling or final disposal.

### 3.2 The Municipal Solid Wastes (Management and Handling) Rules, 2000

**"Municipal Solid Waste"** includes commercial and residential wastes generated in municipal or notified areas in either solid or semi-solid form excluding industrial hazardous wastes but including treated bio-medical wastes.

**"Disposal"** means final disposal of municipal solid wastes in terms of the specified measures to prevent contamination of ground-water, surface water and ambient air quality.

**"Processing"** means the process by which solid wastes are transformed into new or recycled products;

**"Recycling"** means the process of transforming segregated solid wastes into raw materials for producing new products, which may or may not be similar to the original products

**"Storage"** means the temporary containment of municipal solid wastes in a manner so as to prevent littering, attraction to vectors, stray animals and excessive foul odour.

### **3.3 Basel Convention**

Basel Convention covers all discarded/disposed materials that possess hazardous characteristics as well as all wastes considered hazardous on a national basis. Annex VIII, refers to E-waste, which is considered hazardous under Art. 1, par. 1(a) of the Convention: A1180 Waste electrical and electronic assemblies or scrap containing components such as accumulators and other batteries included on list A, mercury-switches, glass from cathode-ray tubes and other activated glass and PCB-capacitors, or contaminated with Annex I constituents (e.g., cadmium, mercury, lead, polychlorinated biphenyl) to an extent that they possess any of the characteristics contained in Annex III. Annex IX, contains the mirror entry, B1110 Electrical and Electronic assemblies given below.

- Electronic assemblies consisting only of metals or alloys
- Waste electrical and electronic assemblies or scrap (including printed circuit boards) not containing components such as accumulators and other batteries included on List A, mercury-switches, glass from cathode-ray tubes and other activated glass and PCB-capacitors, or not contaminated with Annex 1.

## CHAPTER 4

### CLASSIFICATION OF E-WASTE

#### 4.0 Composition of E-Waste

Composition of e-waste is very diverse and differs in products across different categories. It contains more than 1000 different substances, which fall under “hazardous” and “non-hazardous” categories. Broadly, it consists of ferrous and non-ferrous metals, plastics, glass, wood & plywood, printed circuit boards, concrete and ceramics, rubber and other items. Iron and steel constitutes about 50% of the e-waste followed by plastics (21%), non ferrous metals (13%) and other constituents. Non-ferrous metals consist of metals like copper, aluminium and precious metals ex. silver, gold, platinum, palladium etc. The presence of elements like lead, mercury, arsenic, cadmium, selenium, and hexavalent chromium and flame retardants beyond threshold quantities in e-waste classifies them as hazardous waste.

#### 4.1 Components of E-Waste

E-waste has been categorized into three main categories, Viz. Large Household Appliances, IT and Telecom and Consumer Equipment. Refrigerator and Washing Machine represent large household appliances, Personal Computer, Monitor and Laptop represent IT and Telecom, while Television represents Consumer Equipment. Each of these E-waste items has been classified with respect to twenty six common components, which could be found in them. These components form the “Building Blocks” of each item and therefore they are readily “identifiable” and “removable”. These components are metal, motor/ compressor, cooling, plastic, insulation, glass, LCD, rubber, wiring/ electrical, concrete, transformer, magnetron, textile, circuit board, fluorescent lamp, incandescent lamp, heating element, thermostat, BFR-containing plastic, batteries, CFC/HCFC/HFC/HC, external electric cables, refractory ceramic fibers, radio active substances and electrolyte capacitors (over L/D 25 mm). The kinds of components, which are found in Refrigerator, Washing Machine, Personal Computers (PC) and TVs, are described in **table 4.1**. The observations from the analysis of table 4.1 are given below.

1. Radioactive substances, refractory ceramic fibers, electrolyte capacitors (over L/D 25 mm), textile and magnetron are not present in any item.
2. Plastic, circuit board and external electric cables are present in majority of items. BFR containing plastic is present in refrigerator, laptop and television.
3. Refrigerators are unique items because of presence of CFC/HCFC/HFC/HC, cooling, insulation, incandescent lamp and compressor.

4. Heating element is found in washing machine, while thermostat is found in both refrigerator and washing machine.
5. Fluorescent lamp is found only in laptop
6. Metal and motor are found in majority of items except refrigerator
7. Transformer is not found in washing machine and refrigerator
8. CRT is found in personal computer and TV, while LCD is found in PC and TV
9. Batteries are found in PC and laptop
10. Concrete is found in washing machine
11. Rubber is found in refrigerator and washing machine
12. Wiring/ Electrical is found in all the items

Large household appliance (refrigerator) may consist of electric motor, a circuit board, a transformer, capacitor, thermal insulation, switches, wiring, plastic casing that contain flame retardants etc. A typical washing machine may consist of the metal casing, concrete ballast, inner and outer drums, a motor, a pump, washing cycle controller unit, switches and other components. The latest trends in these appliances is the phase out of the use of ODS and improvement of energy efficiency. Old washing machines are likely to contain large capacitors, while in relatively new machines, variable speed motors are controlled from the circuit board. IT and Telecom equipments sector is observing a trend of “micro miniaturization”, while CRTs are being replaced by LCD screens. Table 5.1 indicates that the range of different items found in E-waste is diverse classifying it a waste of complex nature. However, it shows that E-waste from these items can be dismantled into relatively small number of common components for further treatments. The composition and hazard content of each of these components is being described in following section to establish the overall hazardousness of each item of E-waste.



**Table 4.1: Components in WEEE (by Category)**

	Metal	Motor \ Compressor	Cooling	Plastic	Insulation	Glass	CRT	LCD	Rubber	Wiring / Electrical	Concrete	Transformer	Magnetron	Textile	Circuit Board	Fluorescent lamp (ineballast)	Incandescent lamp	Heating element	Thermostat	BFR – containing plastic	Batteries	CFC, HCFC, HFC, HC	External electric cables	Refractory ceramic fibers	Radioactive substances	Electrolyte Capacitors (over L/D 25mm)
<b>Large Household Appliances</b>																										
Refrigerator	■	■	■	■	■	■	-	-	■	■	-	-	-	-	-	-	■	-	■	■	-	■	■	-	-	-
Washing Machine	■	■	-	■	-	■	-	-	■	■	■	-	-	-	■	-	-	■	■	-	-	-	■	-	-	○
<b>IT &amp; Telecom</b>																										
Personal Computer (Base & Keyboard)	■	■	-	■	-	-	-	-	-	■	-	■	-	-	■	-	-	-	-	-	■	-	■	-	-	-
Personal Computer (Monitor)	-	-	-	■	-	-	■	■	-	-	-	-	-	-	■	-	-	-	-	-	-	-	■	-	-	-
Laptop	-	■	-	■	-	-	-	■	-	■	-	■	-	-	■	■	-	-	-	■	■	-	■	-	-	-
<b>Consumer Equipment</b>																										
Television	■	-	-	■	-	-	■	-	-	■	-	■	-	-	■	-	-	-	-	■	-	-	■	-	-	-

- Present as a component
- Possible presence as a component

## 4.2 Possible hazardous substances present in e-waste

The possible substance of concern, which may be found in selected E-waste item is given in table 4.2.

**Table 4.2: Possible Hazardous Substances in Components**

Component	Possible Hazardous Content
Metal	
Motor \ Compressor	
Cooling	ODS
Plastic	Phthalate plasticize, BFR
Insulation	Insulation ODS in foam, asbestos, refractory ceramic fiber
Glass	
CRT	Lead, Antimony, Mercury, Phosphors
LCD	Mercury
Rubber	Phthalate plasticizer, BFR
Wiring / Electrical	Phthalate plasticizer, Lead, BFR
Concrete	
Transformer	
Circuit Board	Lead, Beryllium, Antimony, BFR
Fluorescent Lamp	Mercury, Phosphorus, Flame Retardants
Incandescent Lamp	
Heating Element	
Thermostat	Mercury
BFR – containing plastic	BFRs
Batteries	Lead, Lithium, Cadmium, Mercury
CFC, HCFC, HFC, HC	Ozone depleting substances
External electric cables	BFRs, plasticizers
Electrolyte Capacitors (over L/D 25mm)	Glycol, other unknown substances

The substances within the above mentioned components, which cause most concern are the heavy metals such as lead, mercury, cadmium and chromium (VI), halogenated substances (e.g. CFCs), polychlorinated biphenyls, plastics and circuit boards that contain brominated flame retardants (BFRs). BFR can give rise to dioxins and furans during incineration. Other materials and substances that can be present are arsenic, asbestos, nickel and copper. These substances may act as a catalyst to increase the formation of dioxins during incineration. The description about some of these substances where uncertainty exists regarding their “level of concern” based on literature review are given below.

**(1) *Plastics containing Brominated Flame Retardants (BFRs)***

Two families of BFRs have been used in EEE. The first is polybrominated diphenyl ethers (PBDPEs), which includes DBPE (decabromodiphenyl oxide), and PBPE (pentabromodiphenyl oxide). In the electronics industry, DBPE is the dominant PBDPE BFR and is used primarily in computer housings. The second family of BFRs is the phenolics, which includes TBBPA (tetrabromo-bisphenol A). TBBPA (also referred to as TBBA) is used primarily in printed circuit boards.

**(2) *Insulation***

Materials of concern in these components are ODS in insulation foams, asbestos and refractory ceramic fibre.

**(3) *Asbestos***

Asbestos has been used in older appliances such as coffee pots, toasters and irons. Asbestos was also a component of some heaters and other items that benefit from the heat resistant properties of the material. Modern appliances do not contain asbestos. However, if a heating appliance is very old (ex. pre 1985), the chances of finding asbestos are high.

**(4) *Refractory Ceramic Fibers (RCFs)***

Respirable RCFs are classified as category 2 carcinogens, which takes into account observation from recent studies involving laboratory animals that suggest these fibers may have potential to cause lung cancer or mesothelioma in humans. This classification, which became effective in January 1999, does not represent a ban on use. However it does mean that any work with RCF is subject to stringent controls<sup>13</sup>.

**(5) *Liquid Crystal Display (LCDs)***

LCD consists of liquid crystals, which are embedded between thin layers of glass and electrical elements. A cellular phone display can contain about 0.5 mg of liquid crystals, a notebook display about half a gram. The LCD, first used predominately in notebook and laptop computers, is now moving into the desktop computer market. Most LCDs have a lamp. For small LCDs, the main consideration for the dismantler will be whether or not there is a lamp present. Liquid crystals come under suspicion of being a health hazard. About 50,000 liquid crystal substances are known, but only about 500 are key components for LCD technology. Examples are MBBA (4-methoxybenzylidene-4-butylaniline) and 5CB (4-pentyl-4'-cyanobiphenyl). Currently there appear to be no toxicological test results on liquid crystal materials.

**(6) Components containing Plasticisers/Stabilisers**

The concerns here include the use of phthalate plasticizers and lead stabilisers in plastics and rubbers. For example, dibutyl phthalate and diethylhexyl phthalate are considered “Toxic for Reproduction” at concentrations  $\geq 0.5\%$ .

**(7) Circuit Boards**

While most boards are typically 70% non metallic, they also contain about 16% copper, 4% solder and 2% nickel along with iron, silver, gold, palladium and tantalum. Approximately 90% of the intrinsic value of most scrap boards is in the gold and palladium content. Consequently, traditional reprocessing of circuit boards has concentrated on the recovery of metals values. Some of the components found in circuit boards are described below.

**(8) Flame Retardants**

The circuit board laminate consists of a glass fibre reinforced epoxy and is likely to contain flame retardant substances at a level of about 15%. The main flame retardant material used in circuit boards is tetrabromobisphenol-A (TBBPA). TBBPA is claimed to have a lower dioxin generation potential than PBDE (pentabromodiphenylether).

**(9) Lead**

The typical Pb/Sn solder content in scrap of printed circuit boards ranges between 4-6%, consequently lead represents 2-3% of the weight of the original board. The concerns about lead in circuit appear to relate to the possibility of lead leaching from circuit boards disposed of in landfills.

**(10) Mercury**

It is estimated that 22% of the yearly world consumption of mercury is used in electrical and electronic equipment (ex. in fluorescent lamps). Its use in EEE has declined significantly in recent years. It has been used in thermostats, (position) sensors, relays and switches (ex. on printed circuit boards and in measuring equipment), batteries and discharge lamps. Furthermore, it is used in medical equipment, data transmission, telecommunications, and mobile phones. The estimated concentration level of mercury in computers is 0.002%.

**(11) Beryllium**

Copper beryllium alloys are used in electronic connectors where a capability for repeated connection and disconnection is desired, and thus where solder is not used to make a permanent joint. Such connectors are often gold plated, so that copper oxide is not created on their surfaces, and does not form a non-electrically conductive barrier between the two connectors. A second use of beryllium in the electronics industry is as beryllium oxide, or beryllia. Beryllia transmits heat very efficiently, and is used in heat sinks. These sinks project heat-generating devices by rapidly distributing their heat to a much larger volume and surface area, where it can be further safely discharged into a moving air stream. Beryllia heat sinks have been used in specific designed parts, which are attached to a heat source, and have also been built into specific microelectronic devices as integral parts of the substrates of those devices. Beryllium oxide (BeO) or beryllia is found in some power transistors, transistor and valve bases, and some resistors.

**(12) Capacitors**

Capacitors containing hazardous substances have been classified into two types i.e. electrolytic capacitors and capacitors containing Polychlorinated Biphenyls.

**(13) Electrolyte Capacitors**

Aluminum capacitors are small and cheap for their capacity and can be found in sizes from <1 uF to over 1 farad. They are commonly available up to 450 volts working voltage, with some up to at least 600 volts, much higher than other types of electrolytic capacitors. Aluminum electrolytic capacitors use a layer of aluminum oxide grown on aluminum foil. The aluminum foil forms one electrode the rest is a non-aqueous electrolyte in thin paper separator, and another foil layer for the cathode. The original electrolyte formulae usually comprised a glycol or amine, in which a conductive salt (e.g. sodium borate) is dissolved, plus a trace (1-2%) of water. Many variations on this have been used over the years, although glycol is still often used. Typical contents of a 100µF 10V aluminum capacitor are given in table 4.3.

**Table 4.3: Contents of a 100µF 10V aluminum capacitor**

<b>Part</b>	<b>Contents (g)</b>	<b>Contents (%)</b>
Aluminum foil	0.17	16%
Paper and electrolyte	0.18	17%
Capsule (aluminum)	0.35	33%
Copper wire	0.12	11%
Rubber lid	0.23	22%

The capacitor is rendered hazardous if an accompanying threshold concentration is more than 25%. Thus, with electrolyte accounting for <17% of a typical capacitor, the glycol content would not render the capacitor hazardous.

**(14) *Capacitors containing Poly Chlorinated Biphenyls (PCBs)***

PCBs were extensively used in electrical equipment such as capacitors and transformers. Their use in open applications was widely banned in 1972 in Europe and they have not been used in the manufacture of new equipment since 1986. Capacitors containing PCBs fall into two categories, according to size. Small capacitors were used in fluorescent/ other discharge lamps and also with fractional horsepower motors used in domestic and light-industrial electrical equipment. Large capacitors were used for power factor correction and similar duties.

**4.3 E-waste scenario**

Globally, WEEE/ E-waste are most commonly used terms for electronic waste. At UNEP web site, it is cited that “e-waste is a generic term encompassing various forms of electrical and electronic equipment (EEE) that are old, end-of-life electronic appliances and have ceased to be of any value to their owners”. There is no standard definition of WEEE/E-waste. A number of countries have come out with their own definitions, interpretation and usage of the term “E-waste/WEEE”. The most widely accepted definition of WEEE/ E-waste is as per EU directive, which is followed in member countries of European Union and other countries of Europe. At first WEEE/E-waste definition as per EU directive has been described followed by description of definitions in Canada, Japan, USA, Basel Convention and OECD.

**Indian Scenario**

The electronics industry has emerged as the fastest growing segment of Indian industry both in terms of production and exports. The share of software services in electronics and IT sector has gone up from 38.7 per cent in 1998-99 to 61.8 percent in 2003-04. A review of the industry statistics show that in 1990-91, hardware accounted for nearly 50% of total IT revenues while software's share was 22%. The scenario changed by 1994-95, with hardware share falling to 38% and software's share rising to 41%. This shift in the IT industry began with liberalization, and the opening up of Indian markets together with which there was a change in India's import policies vis-à-vis hardware leading to substitution of domestically produced hardware by imports. Since the early 1990s, the software industry has been growing at a compound annual growth rate of over 46% (supply chain management, 1999). Output of computers in value terms, for example, increased by 36.0, 19.7 and 57.6 per cent in 2000-01, 2002-03, and

2003-04, respectively. Within this segment, the IT industry is prime mover with an annual growth rate of 42.4% between 1995 and 2000. By the end of financial year 2005-06, India had an installed base of 4.64 million desktops, about 431 thousand notebooks and 89 thousand servers. According to the estimates made by the Manufacturers Association of Information Technology (MAIT) the Indian PC industry is growing at a 25% compounded annual growth rate.

The e-waste inventory based on this obsolescence rate and installed base in India for the year 2005 has been estimated to be 146180.00 tonnes. This is expected to exceed 8,00,000 tonnes by 2012. ***There is a lack of authentic and comprehensive data on e-waste availability for domestic generation of e-waste and the various State Pollution Control Boards have initiated the exercise to collect data on e-waste generation.***

Sixty-five cities in India generate more than 60% of the total e-waste generated in India. Ten states generate 70% of the total e-waste generated in India. Maharashtra ranks first followed by Tamil Nadu, Andhra Pradesh, Uttar Pradesh, West Bengal, Delhi, Karnataka, Gujarat, Madhya Pradesh and Punjab in the list of e-waste generating states in India. Among top ten cities generating e-waste, Mumbai ranks first followed by Delhi, Bangalore, Chennai, Kolkata, Ahmedabad, Hyderabad, Pune, Surat and Nagpur. There are two small e-waste dismantling facilities are functioning in Chennai and Bangalore. There is no large scale organized e-waste recycling facility in India and the entire recycling exists in un-organized sector.

#### **4.4 Basis for Defining e-waste**

E-waste definition is driven by three major drivers as given below:

1. Definition of “electrical and electronic equipment”
2. Description of its ‘loss of utility”
3. “Way of disposal”

The most widely accepted definition of e-waste is as per the EU directive. The major features of this definition include definition of “electrical and electronic equipment”, its classification into ten categories and its extent as per voltage rating of 1000 volts for alternating current and 1500 volts for direct current. Electrical and electronic equipment have been further classified into “components”, “sub-assemblies” and “consumables”. In some definitions, the words “product” and ‘assemblies” or the phrase “product and components” are mentioned in place of “equipment”. The words ‘discarded”, “end of life” and “dispose/ disposal” are invariably used in definitions to describe ‘loss of utility” of electrical and electronic equipment. Similarly, words/ phrases “used goods”, “scrap” and “waste” are invariably used to describe “way of disposal”. These words are being used to harmonize e-waste with least disturbance to existing policies regulations, where sometimes it is treated separately or under hazardous or solid waste management.

“Loss of Utility” indicates variation in consumer behavior, while “Way of Disposal” broadly reflects different national policies and regulations for considering waste as “pollutant” or a ‘resource”. In other countries, the evolution of e-waste definition started with disposal of computers and televisions where CRT disposal is a major environmental concern. Therefore, computers and televisions were included into coverage of electronic equipment with amendments expected to include other items in future.

#### 4.5 Proposed definition of E-Waste

E-waste comprises of wastes generated from used electronic devices and house hold appliances which are not fit for their original intended use and are destined for recovery, recycling or disposal. Such wastes encompasses wide range of electrical electronic devises such as computers, hand held cellular phones, personal stereos, including large household appliances such as refrigerators, air conditioners etc. E-wastes contain over 1000 different substances many of which are toxic and potentially hazardous for environment and human health, if these are not handled in an environmentally sound manner. The e-waste definitions and terminologies used globally are given in **Annexure – I**.

##### 4.5.1 Proposed Definition

The analysis of hazardous waste rules 2003 and municipal waste rules 2000 with respect to the three drivers describing the E-waste definition is given in table 4.4.

**Table 4.4: E-waste reference in Indian regulations with respect to identified drivers**

E-waste/ Drivers	Drivers		
	Definition of Electrical and Electronic Equipment	Definition of loss of utility	Definition of way of disposal
“Hazardous” E-waste	Partly covered in Schedule 1 under ‘Electronic Industry” and Schedule 3	<b>X</b>	Definition of word “Disposal” which includes deposit, treatment, recycling and recovery under Hazardous Waste (Management & Handling) rules 2003.
“Non-Hazardous E-waste	<b>X</b>	<b>X</b>	Definition of word “Storage, “Processing”, “Recycling” and “Disposal” under Municipal Solid Waste (Management and Handling) Rules 2000



Schedules 1, 2 and 3 of the Hazardous Wastes Rules, 2003 show that ambit of these sub clauses is so comprehensive that it will cover each steps of e-waste 'disposal' starting from dismantling, recycling and extraction of metals and import and export. e-waste coverage in Schedule 3 of Hazardous Wastes Rules, 2003 is same as that of Basel Convention. Therefore, the proposed definition of e-waste, which may be incorporated in the regulation, is given below:

The Hazardous Wastes (Management and Handling) Rules, 2003

Under Rule 3, "Definitions", E-waste can be defined as **"Waste Electrical and Electronic Equipment including all components, sub assemblies and their fractions except batteries falling under these rules.**

#### **4.6 Reduction of the Hazardous Substances (RoHS) in the Electronic & electrical Equipments**

There is an increasing trend in the reduction in the use of hazardous substances such as lead, cadmium, mercury, polychlorinated biphenyls (pcbs) and other toxic and hazardous substances for which safe substitutes have been found. Many countries have adopted the RoHS regulations in the manufacture of electrical and electronic equipments. The Threshold Limits for each of the hazardous substances is given in **Annexure - II**.

#### **4.7 Extended Producer Responsibility (EPR)**

The Extended Producer Responsibility (EPR) is an environment protection strategy that makes the producer responsible for the entire life cycle of the product, especially for take back, recycle and final disposal of the product. Thus the producers' responsibility is extended to the post-consumer stage of the product life cycle. This needs to be included in the legislative framework making EPR a mandatory activity associated with the production of electronic and electrical equipments over a period of time.

##### **4.7.1 Guidelines for the electrical and electronic equipments manufacturers**

The producers of all electronic and electrical equipments should be allowed to levy an appropriate fee on the product at the point of sale, to facilitate the operation of the buy back system and enable to provide standardized rates to the customers. The rate list should be made available to the customer.

The producers shall take the responsibility of collection of the end of use equipment through facilitating the establishment of a common collection point and suitable storage infrastructure. Public Private Partnership (PPP) models may also be considered for the same.

The producers of all electronic and electrical equipments may provide the following information along with the products:

- (1) Enlisting of hazardous constituents present in the equipment.
- (2) A detailed booklet on the handling of the equipment in case of accidental breakage or damage.
- (3) A booklet containing instructions on do's and don'ts.
- (4) Details on the disposal of the end of use of the product.
- (5) List of collection centres or organizations for the deposition of the equipment after use giving contact details such as address, telephone no.s, 24 hr helpline and e-mail.
- (6) Facilitate pick-up services.

## Chapter 5

### GUIDELINES FOR ENVIRONMENTALLY SOUND MANAGEMENT FOR E-WASTE

The Environmentally Sound Technologies for e-waste treatment involves complex treatment rationale is driven by “Material Flow”. This is compared with best available technology and e-waste treatment technology currently used in India.

#### 5.1 E-waste Composition and Recycle Potential

The consumption of e-waste and its recyclable potential is specific for each appliance. In order to handle this complexity, the parts/materials found in e-waste may be divided broadly into six categories as follows:

- Iron and steel, used for casings and frames
- Non-ferrous metals, especially copper used in cables, and aluminum
- Glass used for screens, windows
- Plastic used as casing, in cables and for circuit boards
- Electronic components
- Others (rubber, wood, ceramic etc.).

**Annexure-III** provides an overview of the composition of the three appliances selected for the study. The recovery potential (typical values) of items of economic value from PC, TV and Refrigerators has been described in **Annexure-IV**, **Annexure-V**, and **Annexure-VI** respectively.

#### 5.2 Assessment of Hazardousness of e-waste

Guidelines for assessment of hazardousness of E-waste have been described in terms of basis, rationale and approach and methodology.

##### 5.2.1 Basis

Assessment of hazardousness of E-waste or its component has been carried out based on Indian environmental regulations on hazardous waste, “The hazardous waste (Management and handling) Rules 2003”.

##### 5.2.2 Rationale

A number of global publications have mentioned that the scope of EU’s WEEE Directives and RoHS is narrow with respect to description of hazardousness of WEEE. Therefore, the Indian regulation has been taken as basis of determining hazardousness of E-waste, where Schedule 1 lists hazardous waste similar to

'absolute" entry (irrespective of concentration) in "European Waste Catalogue" and Schedule 2 lists hazardous waste similar to " mirror" entry Greater than or equal to the threshold limit value in "European Waste Catalogue".

### **5.2.3 Approach and Methodology**

The approach and methodology to determine the hazardousness has been described in following steps as shown in figure 5.1. This approach follows the basis used by "Department for Environment, Food and Natural Affairs", Government of United Kingdom to classify E-waste. However, it has been customized as per Indian situation.

#### **Step 1: Identify the E-waste category item**

The identification includes the E-waste items and its tentative year of manufacture. The year of manufacture gives a number of information ex. Technology and likely component present in the E-waste.

#### **Step 2: Identify the E-waste composition or determine it**

The identification of E-waste composition or its components can be determined by its year of manufacture. Ideally, industry association should maintain record of "Electrical and Electronic Equipment" composition, which should be regularly updated to facilitate its treatment, once it becomes E-waste. In case of doubt, carry out testing of E-waste to find out the concentration.

#### **Step 3: Identify possible hazardous content in E-waste**

If the E-waste has hazardous content, then refer schedule 1 and schedule 2 of "The hazardous waste (Management and handling) Rules 2003". A comparison of thresholds of hazardous substances followed in Europe with respect to that mentioned in Indian regulations, which may occur in E-waste, is given at **Annexure - VII**.

#### **Step 4: Identify, whether the E-waste component is hazardous or the entire E-waste item is hazardous.**

The determination of hazardousness of E-waste from washing machine, refrigerator, computer monitor and personal computer is given in appendix 1. The contents of these E-waste items have been taken from the data of globally accepted data of industry associations.

It can be concluded that E-waste generated from televisions, monitors and personal computers is hazardous in nature as per schedule 1 and schedule 2 of "The hazardous waste (Management and handling) Rules 2003". A comparison of the thresholds mentioned in Indian regulations with that of thresholds followed in Europe for E-waste shows that they are stricter. It can also be inferred that E-waste/ components, which are hazardous in nature need to be covered under the purview of "The hazardous waste (Management and handling) Rules 2003", The Batteries (Management and Handling) Rules, 2001, The Ozone Depleting Substances (Regulation and Control) Rules, 2000.

**Figure 5.1: Approach and Methodology for assessment of hazardousness of E-waste**

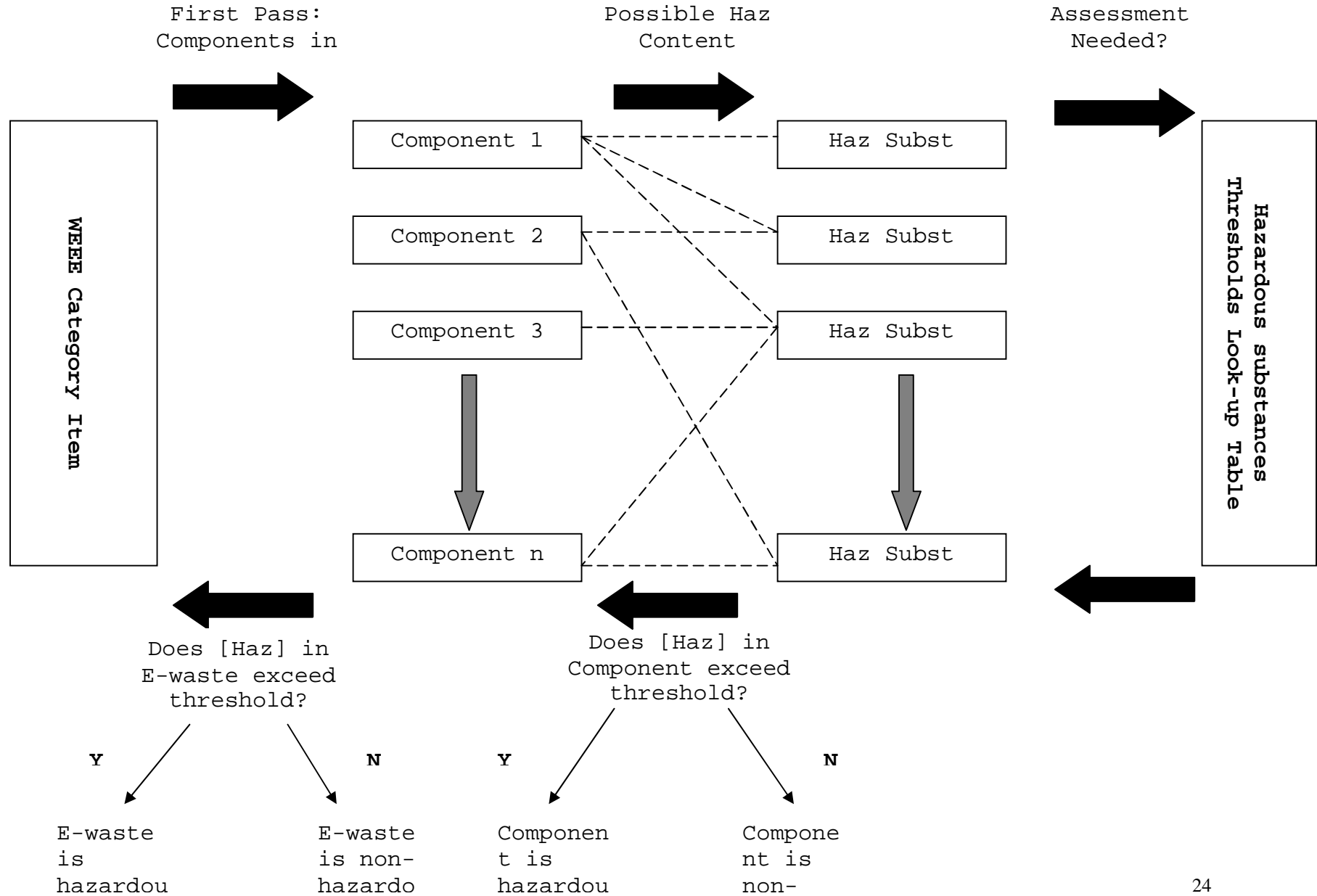

### 5.3 Recycling, Reuse and Recovery Options

The composition of e-waste consists of diverse items like ferrous and non ferrous metals, glass, plastic, electronic components and other items and it is also revealed that e-waste consists of hazardous elements. Therefore, the major approach to treat e-waste is to reduce the concentration of these hazardous chemicals and elements through recycle and recovery. In the process of recycling or recovery, certain e-waste fractions act as secondary raw material for recovery of valuable items. The recycle and recovery includes the following unit operations.

**(i) Dismantling:**

Removal of parts containing dangerous substances (CFCs, Hg switches, PCB); removal of easily accessible parts containing valuable substances (cable containing copper, steel, iron, precious metal containing parts, e.g. contacts).

**(ii) Segregation of ferrous metal, non-ferrous metal and plastic**

This separation is normally done in a shredder process.

**(iii) Refurbishment and reuse:**

Refurbishment and reuse of e-waste has potential for those used electrical and electronic equipments which can be easily refurbished to put to its original use.

**(iv) Recycling/recovery of valuable materials**

Ferrous metals in electrical are furnaces, non-ferrous metals in smelting plants, precious metals in separating works.

**(v) Treatment/disposal of dangerous materials and waste**

Shredder light fraction is disposed of in landfill sites or sometimes incinerated (expensive), CFCs are treated thermally, PCB is incinerated or disposed of in underground storages, Hg is often recycled or disposed of in underground landfill sites.

***The value of recovery from the elements would be much higher if appropriate technologies are used.***

### 5.4 Treatment & Disposal Options

The presence of hazardous elements in e-waste offers the potential of increasing the intensity of their discharge in environment due to landfilling and incineration. The potential treatment disposal options based on the composition are given below:

- Landfilling
- Incineration

## **Landfilling**

The literature review reveals that degradation processes in landfills are very complicated and run over a wide time span. At present it is not possible to quantify environmental impacts from E-waste in landfills for the following reasons:

- Landfills contain mixtures of various waste streams;
- Emission of pollutants from landfills can be delayed for many years;
- According to climatic conditions and technologies applied in landfills (e.g. leachate collection and treatment, impermeable bottom layers, gas collection), data on the concentration of substances in leachate and landfill gas from municipal waste landfill sites differs with a factor 2-3.

One of the studies on landfills reports that the environmental risks from landfilling of e-waste cannot be neglected because the conditions in a landfill site are different from a native soil, particularly concerning the leaching behavior of metals. In addition it is known that cadmium and mercury are emitted in diffuse form or via the landfill gas combustion plant. Although the risks cannot be quantified and traced back to e-waste, landfilling does not appear to be an environmentally sound treatment method for substances, which are volatile and not biologically degradable (Cd, Hg, CFC), persistent (PCB) or with unknown behaviour in a landfill site (brominated flame retardants). As a consequence of the complex material mixture in e-waste, it is not possible to exclude environmental (long-term) risks even in secured landfilling.

## **Incineration**

Advantage of incineration of e-waste is the reduction of waste volume and the utilization of the energy content of combustible materials. Some plants remove iron from the slag for recycling. By incineration some environmentally hazardous organic substances are converted into less hazardous compounds. Disadvantage of incineration are the emission to air of substances escaping flue gas cleaning and the large amount of residues from gas cleaning and combustion.

There is no available research study or comparable data, which indicates the impact of e-waste emissions into the overall performance of municipal waste incineration plants. Waste incineration plants contribute significantly to the annual emissions of cadmium and mercury. In addition, heavy metals not emitted into the atmosphere are transferred to slag and exhaust gas residues and can re-enter the environment on disposal. Therefore, e-waste incineration will increase these emissions, if no reduction measures like removal of heavy metals from are taken.



## 5.5 E-waste Recycling/Treatment technologies in India

In this context, it is pertinent to assess the e-waste recycling scenario in India, where recycling of e-waste to recover items of economic value is carried out.

The assessment of e-waste recycling sector in India indicates that e-waste trade starts from formal dismantling sector and moves to informal recycling sector. e-waste movement from formal to informal sector is driven by trade and can be tracked by trade value chain. This e-waste trade value chain can be mapped based on material flow from formal sector to informal sector. An example of this chain mapped during “Delhi Study” given in **Annexure – VIII**.

This chain was identified considering bottom-up approach with three levels of e-waste generation hierarchy. The three levels of e-waste generation hierarchy give rise to three types of stakeholders involved in e-waste trade as described below.

1. 1st Level – Preliminary e-waste Generators.
2. 2nd Level – Secondary e-waste Generators.
3. 3rd Level – Tertiary e-waste Generators.

The input to “Preliminary e-waste Generator” comes from formal organized market like manufacturers, importers, offices and organized markets, where e-waste from domestic consumers comes either in exchange schemes or as a discarded item. Therefore, the major stakeholders are scrap dealers/ dismantlers who purchase e-waste from the first level in bulk quantities. These stakeholders have limited capacity of dismantling and are involved in trading of e-waste with “Secondary e-waste Generators”. The market between first and second level is semi formal i.e. part formal, while the market between second and third level is completely informal. Stakeholders falling under “Secondary e-waste Generators” have limited financial capacity and are involved in item/ component wise dismantling process and segregation ex. Dismantling of CRT, PCB, plastic and glass from e-waste. ‘Tertiary Level Stakeholders” are the major stakeholders between second and third level and are metal extractors, plastic extractors and electronic item extractors. They use extraction process, which are hazardous in nature. The characteristics of emissions from e-waste treatment in semi formal and informal sector in India are as follows:

1. Generation of mixed e-waste fractions along with hazardous waste after dismantling
2. Generation of effluents during metal extraction ex. Acid bath process for copper extraction from printed circuit board
3. Air emissions due to burning of printed circuit board
4. Inefficient secondary raw material generation

The entire e-waste treatment is being carried out in an unregulated environment, where there is no control on emissions. There are two e-waste dismantling facilities in formal sector in India. These facilities are M/s. Trishiraya Recycling facilities, Chennai and M/s E-Parisara, Bangalore.

## CHAPTER 6

### ENVIRONMENTALLY SOUND TREATMENT TECHNOLOGY FOR E-WASTE

#### 6.1 Environmentally sound E-waste treatment technologies

Environmentally sound E-waste treatment technologies are used at three levels as described below:

1. 1<sup>st</sup> level treatment
2. 2<sup>nd</sup> level treatment
3. 3<sup>rd</sup> level treatment

#### *Analysis*

All the three levels of e-waste treatment are based on material flow. The material flows from 1<sup>st</sup> level to 3<sup>rd</sup> level treatment. Each level treatment consists of unit operations, where e-waste is treated and out put of 1st level treatment serves as input to 2<sup>nd</sup> level treatment. After the third level treatment, the residues are disposed of either in TSDF or incinerated. The efficiency of operations at first and second level determines the quantity of residues going to TSDF or incineration. The simplified version of all the three treatments is shown in figure 6.1, while a comprehensive version detailing each stage is given at **Annexure – IX**. EST at each level of treatment is described in terms of input, unit operations, output and emissions.

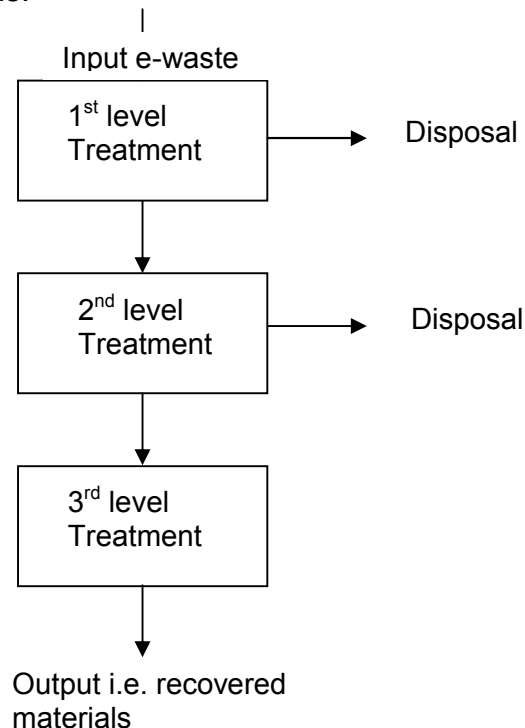

Figure 6.1: Simplified version of EST for e-waste

### 6.1.1 EST for 1<sup>st</sup> Level Treatment

Input: e-waste items like TV, refrigerator and Personal Computers (PC)

Unit Operations: There are three units operations at first level of e-waste treatment

1. Decontamination : Removal of all liquids and Gases
2. Dismantling -manual/mechanized breaking
3. Segregation

All the three unit operations are dry processes, which do not require usage of water.

#### 1. Decontamination

The first treatment step is to decontaminate e-waste and render it non-hazardous. This involves removal of all types of liquids and gases (if any) under negative pressure, their recovery and storage.

#### 2. Dismantling

The decontaminated e-waste or the e-waste requiring no decontamination are dismantled to remove the components from the used equipments. The dismantling process could be manual or mechanized requiring adequate safety measures to be followed in the operations.

#### 3. Segregation

After dismantling the components are segregated into hazardous and non-hazardous components of e-waste fractions to be sent for 3<sup>rd</sup> level treatment.

#### Output:

1. Segregated hazardous wastes like CFC, Hg Switches, batteries and capacitors
2. Decontaminated e-waste consisting of segregated non-hazardous E-waste like plastic, CRT, circuit board and cables

**Emissions:** The emissions coming out of 1<sup>st</sup> level treatment is given in table 6.1.

**Table 6.1: Emissions from 1<sup>st</sup> level E-waste treatment**

<b>Unit Operations/ Emissions</b>	<b>Dismantling</b>	<b>Segregation</b>
Air	√ (fugitive)	X
Water	X	X
Noise	√	√
Land/ Soil Contamination due to spillage	√	√
Generation of hazardous waste	√	√

### 6.1.2 EST for 2<sup>nd</sup> Level Treatment

Input: Decontaminated E-waste consisting segregated non hazardous e-waste like plastic, CRT, circuit board and cables.

Unit Operations: There are three unit operations at second level of E-waste treatment

1. Hammering
2. Shredding
3. Special treatment Processes comprising of
  - (i) CRT treatment consisting of separation of funnels and screen glass.
  - (ii) Electromagnetic separation
  - (iii) Eddy current separation
  - (iv) Density separation using water

The two major unit operations are hammering and shredding. The major objective of these two unit operations is size reduction. The third unit operation consists of special treatment processes. Electromagnetic and eddy current separation utilizes properties of different elements like electrical conductivity, magnetic properties and density to separate ferrous, non ferrous metal and precious metal fractions. Plastic fractions consisting of sorted plastic after 1<sup>st</sup> level treatment, plastic mixture and plastic with flame retardants after second level treatment, glass and lead are separated during this treatment. The efficiency of this treatment determines the recovery rate of metal and segregated E-waste fractions for third level treatment. The simplified version of this treatment technology showing combination of all three unit operations is given in Figure 6.2.

Figure 6.2: Process flow of Non CRT based e-waste treatment

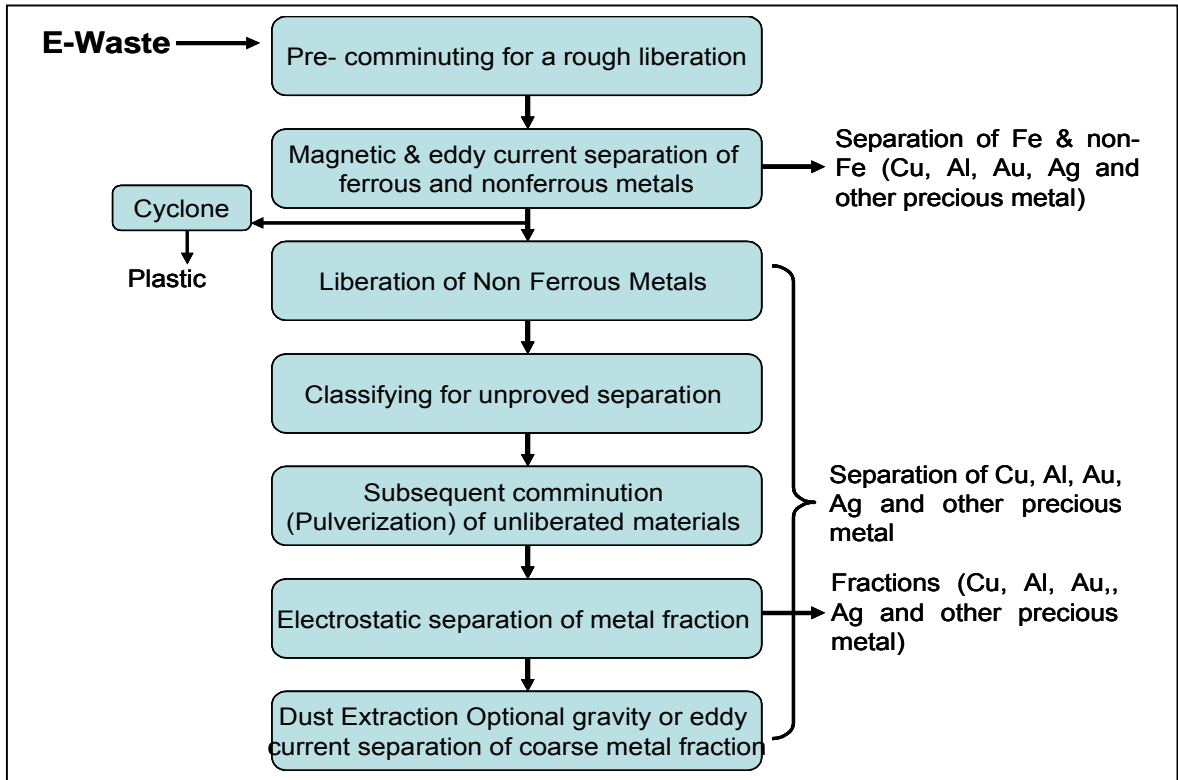

1. The proposed technology for sorting, treatment, including recycling and disposal of E-waste is fully based on dry process using mechanical operations.
2. The pre-comminuting stage includes separation of Plastic, CRT and remaining non CRT based E-waste. Equipments like hammer mill and shear shredder will be used at comminuting stage to cut and pulverize E-waste and prepare it as a feedstock to magnetic and eddy current separation.
3. A heavy-duty hammer mill grinds the material to achieve separation of inert materials and metals.
4. After separation of metals from inert material, metal fraction consisting of Ferrous and Non-Ferrous metals are subjected to magnetic current separation. After separation of Ferrous containing fraction, Non-ferrous fraction is classified into different non-metal fractions, electrostatic separation and pulverization.
5. The ground material is then screened and de dusted subsequently followed by separation of valuable metal fraction using electrostatic, gravimetric separation and eddy current separation technologies to

recover fractions of Copper (Cu), Aluminum (Al), residual fractions containing Gold (Au), Silver (Au) and other precious metals. This results in recovery of clean metallic concentrates, which are sold for further refining to smelters. Sometimes water may be used for separation at last stage.

6. Electric conductivity-based separation separates materials of different electric conductivity (or resistivity) mainly different fractions of non-ferrous metals from E-waste. Eddy current separation technique has been used based on electrical conductivity for non ferrous metal separation from E-waste. Its operability is based on the use of rare earth permanent magnets. When a conductive particle is exposed to an alternating magnetic field, eddy currents will be induced in that object, generating a magnetic field to oppose the magnetic field. The interactions between the magnetic field and the induced eddy currents lead to the appearance of electro dynamic actions upon conductive non-ferrous particles and are responsible for the separation process.
7. The efficacy of the recycling system is dependent on the expected yields/ output of the recycling system. The expected yields/ output from the recycling system are dependent on the optimization of separation parameters. These parameters are given below:
  - Particle size
  - Particle shape
  - Feeding rate/ RPM
  - Optimum operations

Figure 6.3 shows the non-ferrous metal distribution (which forms the backbone of financial viability of recycling system) as a function of size range for PC scrap. It can be seen that aluminum is mainly distributed in the coarse fractions (+6.7 mm), but other metals are mainly distributed in the fine fractions (-5 mm).

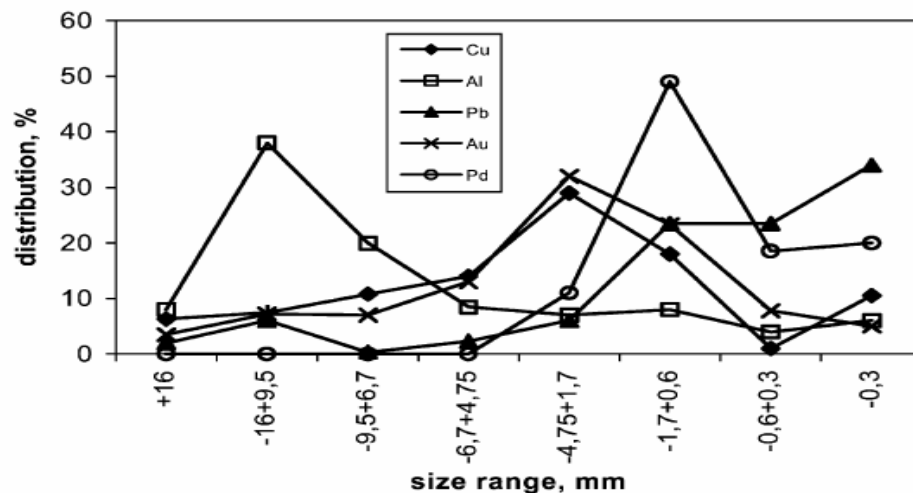

**Figure 6.3: Non- Ferrous Metal Distribution Vs Size range for PC scrap**

Size properties are essential for choosing an effective separation technique. Therefore, eddy current separator is best for granular non-ferrous materials having size greater than 5mm. The eddy current separation will ensure better separation of Al fraction in comparison to fraction containing Cu, Ag and Au.

8. Particle shape is dependent on comminuting and separation. Since hammer mills and screens will be used in the proposed technology, the variations are expected to be the same as that of Best Available Technology (BAT).
9. The feeding rate can be optimized based on the speed and width of the conveyor.

#### **6.1.2.1 CRT treatment technology**

The salient features of CRT treatment technology are given below.

1. CRT is manually removed from plastic/ wooden casing.
2. Picture tube is split and the funnel section is then lifted off the screen section and the internal metal mask can be lifted to facilitate internal phosphor coating.
3. Internal phosphor coating is removed by using an abrasive wire brush and a strong vacuum system to clean the inside and recover the coating. The extracted air is cleaned through an air filter system to collect the phosphor dust.

Different types of splitting technology used are given below.

- NiChrome hot wire cutting

A NiChrome wire or ribbon is wrapped round a CRT and electrically heated for at least 30 seconds to causes a thermal differential across the thickness of the glass. The area is then cooled (e.g. with a water-soaked sponge) to create thermal stress which results in a crack. When this is lightly tapped, the screen separates from the funnel section.

- Thermal shock

The CRT tube is subjected to localized heat followed by cold air. This creates stress at the frit line where the leaded funnel glass is joined to the unleaded panel glass and the tube comes apart.

- Laser cutting

A laser beam is focused inside and this heats up the glass. It is immediately followed by a cold water spray that cools the surface of the glass and causes it to crack along the cut line.

- Diamond wire method

In this method, a wire with a very small diameter, which is embedded with industrial diamond is used to cut the glass as the CRT is passed through the cutting plane.

- Diamond saw separation

Diamond saw separation uses either wet or dry process. Wet saw separation involves rotating the CRT in an enclosure while one or more saw blades cut through the CRT around its entire circumference. Coolant is sprayed on to the surface of the saw blades as they cut. This is to control temperature and prevent warping.

- Water-jet separation

This technology uses a high-pressure spray of water containing abrasive, directed at the surface to be cut. The water is focused through a single or double nozzle-spraying configuration set at a specific distance.

### **6.1.3 3<sup>rd</sup> Level E-waste Treatment**

The 3<sup>rd</sup> level E-waste treatment is carried out mainly to recover ferrous, non-ferrous metals, plastics and other items of economic value. The major recovery operations are focused on ferrous and non ferrous metal recovery, which is either geographically carried out at different places or at one place in an integrated facility. The following sections describe the unit operations, processes, available technology and environmental implications.

#### **6.1.3.1 Input/ Output and Unit Operations**

The input, output and unit operations at 3<sup>rd</sup> level treatment are described in table 6.2.



**Table 6.2: Input/ Output and unit operations for 3<sup>rd</sup> level treatment of e-waste**

Input/ Residues	WEEE	Unit Operation/ Disposal/ Recycling Technique	Output
Sorted Plastic		Recycling	Plastic Product
Plastic Mixture		Energy Recovery/ Incineration	Energy Recovery
Plastic Mixture with FR		Incineration	Energy Recovery
CRT		Breaking/ Recycling	Glass Cullet
Lead Smelting		Secondary Lead Smelter	Lead
Ferrous metal scrap		Secondary steel/ iron recycling	Iron
Non Ferrous metal Scrap		Secondary copper and aluminum smelting	Copper/ Aluminum
Precious Metals		Au/ Ag separation (refining)	Gold/ Silver/ Platinum and Palladium
Batteries (Lead Acid/ NiMH and Li ION)		Lead recovery and smelting Remelting and separation	Lead
CFC		Recovery/ Reuse and Incineration	CFC/ Energy recovery
Oil		Recovery/ Reuse and Incineration	Oil recovery/ energy
Capacitors		Incineration	Energy recovery
Mercury		Separation and Distillation	Mercury

The description of some of the 3<sup>rd</sup> level WEEE/ E-waste processes are described below.

### 6.1.3.2 Plastic Recycling

There are three different types of plastic recycling options i.e. chemical recycling, mechanical recycling and thermal recycling. All the three processes are shown in figure 6.3. In chemical recycling process, waste plastics are used as raw materials for petrochemical processes or as reductant in a metal smelter. In mechanical recycling process, shredding and identification process is used to make new plastic product. In thermal recycling process, plastics are used as alternative fuel.

The two major types of plastic resins, which are used in electronics, are “thermosets” and “thermoplastics”. Thermosets are shredded and recycled because they cannot be re-melted and formed into new products, while thermoplastics can be re-melted and formed into new products.

### 6.1.3.3 Mechanical Recycling Process

Mechanical recycling process is shown in figure 6.4.

The first step is sorting process, where contaminated plastics such as laminated and/ or painted plastics are removed. The methods, which may be used for sorting, are grinding, cryogenic method, abrasion/ abrasive technique, solvent stripping method and high temperature aqueous based paint removal method. Any of the method is used for removal of paints and coating from waste plastics.

**Figure 6.4: Recycling options for managing plastics from end-of-life electronics**

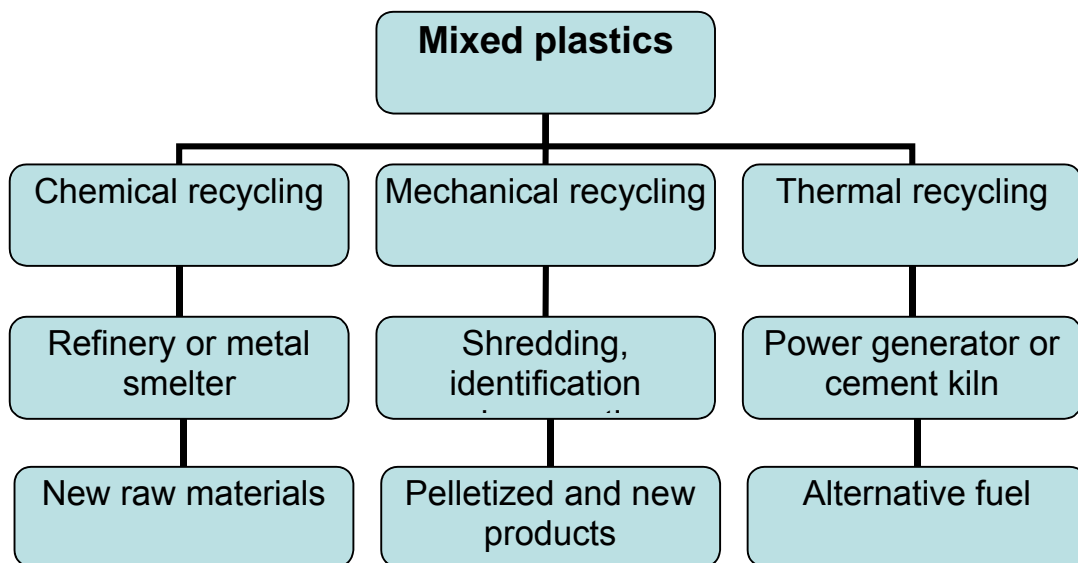

Shear-shredder and hammer mills are generally used for size reduction and liberation of metals (coarse fraction) followed by granulation and milling for further size reduction. Granulators use a fixed screen or grate to control particle size, while hammer mills allow particles between hammers and the walls to exit the mills.

Magnetic separators are used for ferrous metals separation, while eddy current separators are used for non ferrous metals separation. Air separation system is used to separate light fractions such as paper, labels and films. Resin identification can be carried out by using a number of techniques like turboelectric separator, high speed accelerator and X-ray fluorescence spectroscopy.

In hydro cyclones separation technique, plastic fractions are separated using density separation technique, which is made more effective by enhancing material wettability. In turboelectric separation technique, plastic resins are

separated on the basis of surface charge transfer phenomena. Different plastic resins are mixed and contact one another in a rotating drum to allow charging. Negatively charged particles are pulled towards the positive electrode and positively charged particles are pulled towards negative electrode. This technique has been found to be most effective for materials with a particle size between 2-4 mm. In high accelerator separation technique, a high speed accelerator is used to de-laminate shredded plastic waste, which is further separated by air classification, sieve and electrostatics. X-ray fluorescence spectroscopy is effective in identifying heavy metals as well as flame-retardants.

After identification and sorting of different resins, they are extruded and palletized.

**Figure 6.5: Representative process flow diagram for the mechanical recycling of post consumer plastics**

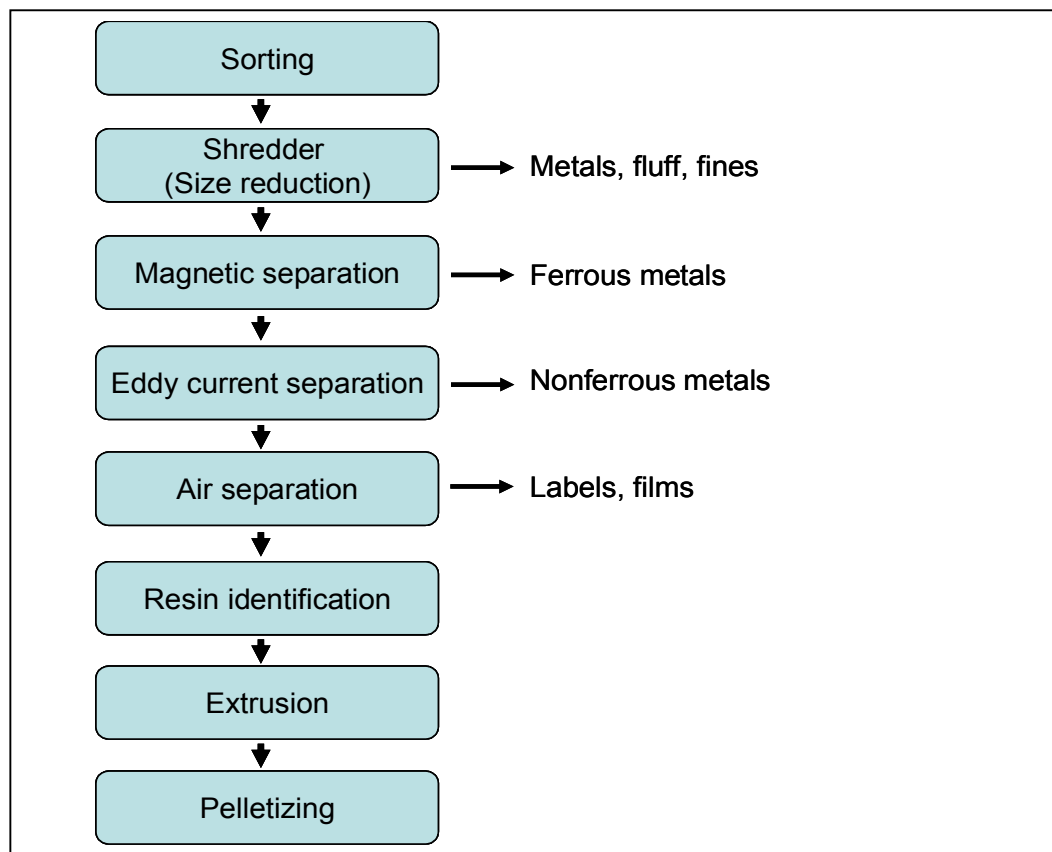

#### 6.1.3.4 Chemical Recycling Process

Chemical recycling process is shown in figure 6.6. This process was developed by the Association of Plastic Manufacturers in Europe (APME). The different steps in this process are given below.

**Figure 6.6: De-polymerization of plastics and conversion processes**

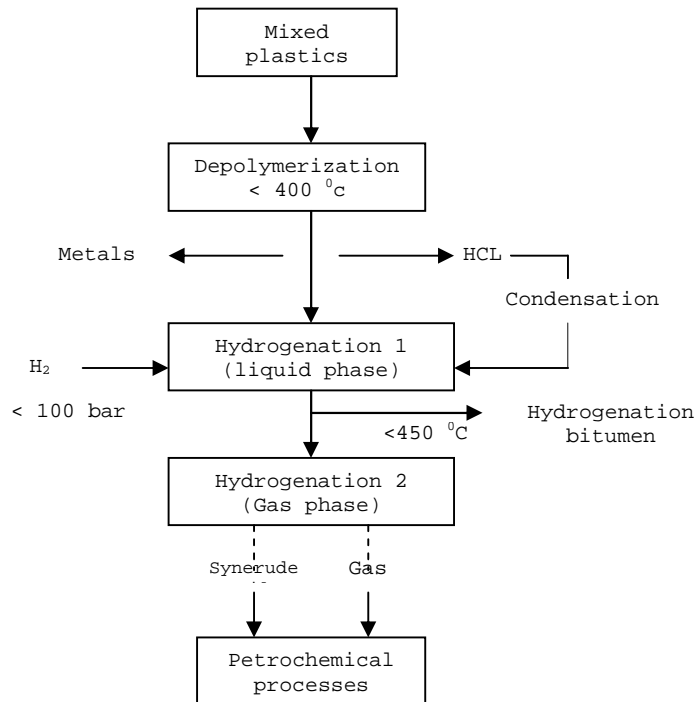

1. Mixed plastic waste is first de-polymerized at about  $350\text{-}400^{\circ}\text{C}$  and dehalogenated (Br and Cl). This step also includes removal of metals.
2. In hydrogenation unit 1, the remaining polymer chains from depolymerized unit are cracked at temperatures between  $350\text{-}400^{\circ}\text{C}$  and hydrogenated at pressure greater than 100 bar. After hydrogenation, the liquid product is subjected to distillation and left over inert material is collected in the bottom of distillation column as residue, hydrogenation bitumen.
3. In hydrogenation unit 2, high quality products like off gas and sync rude are obtained by hydro-treatment, which are sent to petrochemical process.

### 6.1.3.5 Thermal Recycling Process

In thermal recycling process, plastics are used as fuel for energy recovery. Since plastics have high calorific value, which is equivalent to or greater than coal, they can be combusted to produce heat energy in cement kilns. APME has found thermal recycling of plastic as the most environmentally sound option for managing WEEE/ E-waste plastic fraction.

**(i) Metals Recycling**

Metals recycling have been described below in terms of lead recycling, copper recycling and precious metals recycling. After sorting of metal fractions at 2<sup>nd</sup> level e-waste treatment, they are sent to metal recovery facilities. These metal recovery facilities use the following processes to recover metals.

**(ii) Lead Recovery**

Reverberatory furnace and blast furnace are used to recover lead from e-waste fraction. The process is shown in figure 6.7 and involves the following steps.

**Figure 6.7: Processes flow for secondary lead recovery**

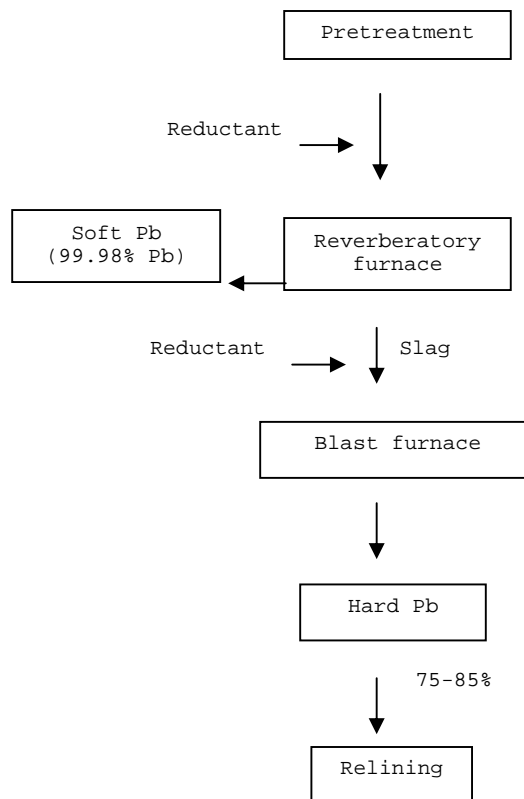

1. A reverberatory furnace is charged with lead containing materials and reductants. In this furnace, the reduction of lead compounds is carried out to produce lead bullion and slag. Lead bullion is 99.9% while slag contains 60-70% wt. % lead and a soft (pure) lead product. The following reactions occur in the reverberatory furnace.

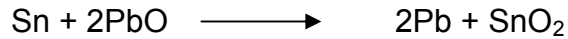
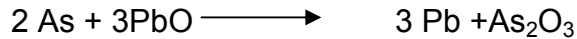
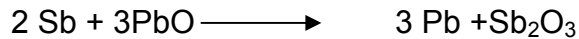
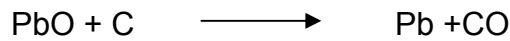

2. Slag in reverberatory furnace is continuously tapped onto a slag caster. It consists of a thin, fluid layer on top of the heavier lead layer in the furnace.
3. Lead bullion is tapped from the furnace when the metal level builds up to a height that only small amounts of lead appear in the slag.
4. Lead is recovered from the slag by charging it in blast furnace along with other lead containing materials and fluxing agents like iron and limestone.
5. Hard lead is recovered from the blast furnace, which contains 75-85 wt. % Pb and 15-25 wt. % Sb. Slag contains 1-3% lead. Slag contains CaO, SiO<sub>2</sub> and FeO.
6. Flue gas emissions from reverberatory furnace are collected by bag house and feedback into the furnace to recover lead. Slag from blast furnace is disposed of in hazardous waste landfill sites.

### (iii) Copper Recycling

The copper recycling process is shown in figure 6.8. It involves the following steps.

1. E-waste fraction containing Cu is fed into a blast furnace, which are reduced by scrap iron and plastics to produce "black copper". Black copper contains 70-85 wt. % copper. The following reactions occur in blast furnace. Sn, Pb and Zn are also reduced as gas fumes.

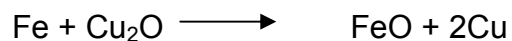

2. The black copper is fed into converter and oxidized using air or enriched oxygen to produce blister copper having 95 wt.

% purity. Sn, Pb and Zn are removed, while Fe is removed as slag.

- Blister copper and scrap Cu are melted and reduced by coke or wood or waste plastic in anode furnace. Other less noble metal are oxidized and removed from blister copper. Sulfur is also removed from the anode furnace. The following reduction reaction occurs in the anode furnace.



- Recovered anode copper is further purified in electrolytic process where it is dissolved in  $\text{H}_2\text{SO}_4$  electrolyte with other elements such as Ni, Zn and Fe. The pure copper 99.99 wt. %) is deposited on the cathodes.
- The by-products of copper recovery process and slag are reused for roof shingles, sand blasting and ballasts for railroads. The anode slime from electrolytic process is used for precious metal recovery. The entire secondary recovery of Cu uses only one-sixth of the energy that would be required to produce Cu from ore.

**Figure 6.8: Process flow for secondary copper recovery**

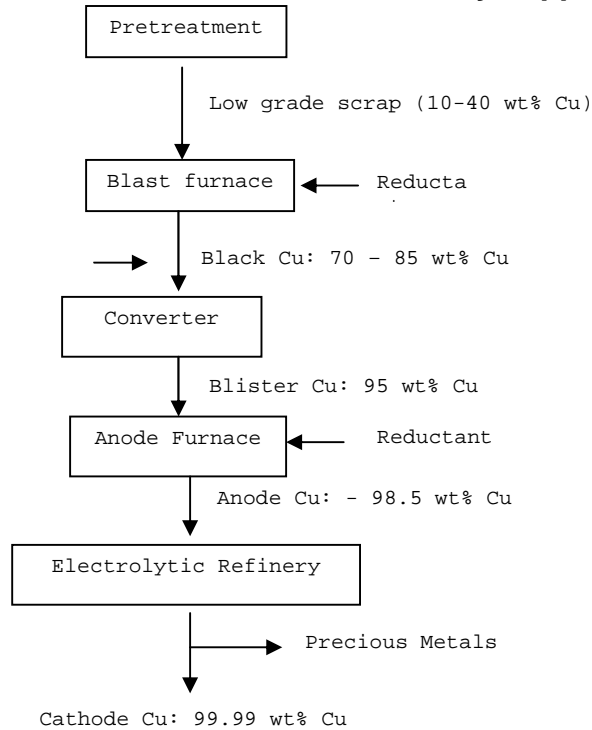

#### (iv) Precious Metals Recovery

The precious metals recovery process is shown in figure 6.9. The anode slime from copper electrolytic process is used for precious metal recovery. The process involves the following steps.

1. Anode slime is leached by pressure.
2. The leached residue is then dried and, after the addition of fluxes, smelted in a precious metals furnace. Selenium is recovered during smelting.
3. The remaining material from smelter is cast into anode and undergoes electrolysis to form high-purity silver cathode and anode gold slime.
4. The anode gold slime is further leached and high purity gold, palladium and platinum sludge are recovered.

**Figure 6.9: Precious metals recovery process**

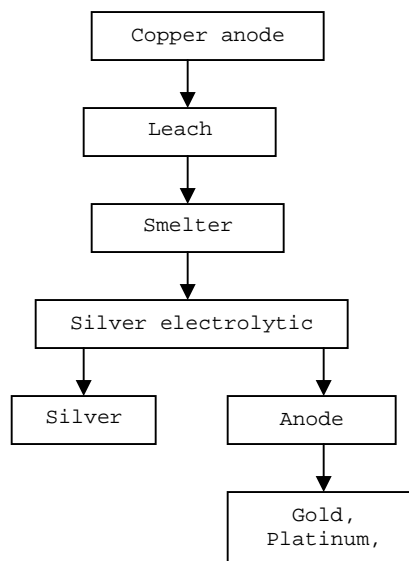

## 6.2 Environmental Impacts of the 1<sup>st</sup>, 2<sup>nd</sup> and 3<sup>rd</sup> level e-waste treatment system

In order to assess environmental impacts of e-waste treatment, an example of environmental impacts of entire Swiss take back and recycling system has been described by comparing it with a baseline system. Swiss take back recycling system included take back, collection, sorting, transportation, dismantling and secondary material processing steps. The baseline system included e-waste disposal by incineration in municipal waste incineration plant (MSWI) and primary production of raw material. The impacts have been assessed with respect to



environmental attributes like acidification, climate change, eutrophication, photochemical oxidation, ozone and resources depletion. A comparison between the two scenarios has been given at **Annexure - X**. The environmental impact of the e-waste recycling system is shown with dark bars on the positive side, while the avoided primary production is shown as bright bars on the negative side of the x-axis. In the first row, the value on the negative side represents the incineration of the complete e-waste in an MSWI plant. In the very last row, the bars are on the reverse side since these bars represent the substitute energy generated by the incineration of organic materials in either of the two systems. It can be inferred that the sum of the burden produced (dark bars) is much lower than the burden avoided (bright bars). The various impact categories are dominated by the primary production of steel and precious metals.

### 6.3 Technology Currently Used in India

For non CRT E-waste, the two E-waste treatment facilities in India use the following technologies.

1. Dismantling
2. Pulverization/ Hammering
3. Shredding
4. Density separation using water

The CRT treatment technology as used by CRT manufacturer in India for discarded CRT's, is shown in Figure 6.10.

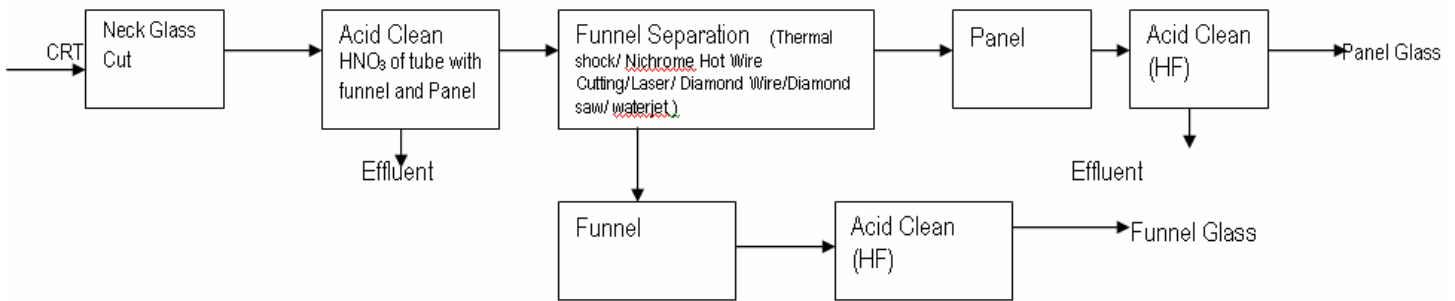

**Figure 6.10: CRT Treatment Options used in India**

However, both the E-waste treatment facilities at Chennai and Bangalore use thermal shock splitting technology along with abrasive wire brush and vacuum system for CRT treatment. There is no interaction with water or acid for CRT treatment in both the facilities.

Output: The output from the 2<sup>nd</sup> level treatment technology is given below:

1. Ferrous metal scrap (secondary raw material)
2. Non ferrous metal scrap mainly copper and aluminum
3. Precious metal scrap mainly silver, gold, palladium
4. Plastic consisting of sorted plastic, plastic with flame retardants and plastic mixture
5. Glass fraction (secondary raw material)
6. Lead (Secondary raw material)

Emissions: The emissions coming out of 2<sup>nd</sup> level treatment is given in table 6.3.

**Table 6.3: Emissions from 2<sup>nd</sup> level E-waste treatment**

Unit Operations/ Emissions	Dismantling	Shredding	Special Treatment Process			
			CR T	Electromagnetic	Eddy Current	Density
Air	√ (fugitive)	√ (fugitive)	X	√ (fugitive)	√ (fugitive)	X
Water	X	X	√	X	X	
Noise	√	√	√	√	√	X
Land/ Soil Contamination due to spillage	√	√	√	√	√	√
Generation of hazardous waste	√	√	√	X	X	X

***The salient features of internationally acceptable for Guidelines for Collection, Refurbishment, Transboundary Movement, Recovery and Recycling of End of Life Mobile Phones are available at web site i.e. <http://www.basel.int/industry/mppiwp/guid-info/index.html>***

#### **6.4 Best Available Technology**

Best available technologies (BAT) have been described by highlighting the existing e-waste treatment process in Switzerland (Europe) and Japan. The salient features of these technologies are given below.

1. The process combines manual and machine procedures.
2. The e-waste is at first cut, crushed and finally sorted into discreet product streams. These streams consist of scrap iron, non-ferrous metal fractions, PC and TV casing components (consisting of wood and plastics), granulates of mixed plastics, cathode ray tubes, printed circuit boards,

copper cables, components containing organic pollutants such as batteries and condensers, and fine particulates (dust).

3. The machine processes include breaking of / crushing the equipment in a hammer mill. Further, the crushed material is separated according to density, granulate size and magnetic properties, and multiple pulverizations by milling using magnetic and eddy current separation systems.

The analysis of the best available technology shows that the process uses a combination of magnetic and electric conductivity based separation. The research publications sites that magnetic separators, in particular, low-intensity drum separators are widely used for the recovery of ferromagnetic metals from non-ferrous metals and other non-magnetic wastes. Over the past decade, there have been many advances in the design and operation of high-intensity magnetic separators, mainly as a result of the introduction of rare earth alloy permanent magnets capable of providing very high field strengths and gradients. Literature cites that magnetic separation leads to recovery of about 90% to 95% of ferrous metal from E-waste. Currently, eddy current separators are almost exclusively used for waste reclamation where they are particularly suited to handling the relatively coarse sized feeds of size > 5 mm. However, recent developments show that eddy current separation process has been designed to separate small particles. It has been reported that eddy current separation leads to more than 90 % recovery of non-ferrous metals from the E-waste.

## **6.5 Available Operating Facilities**

Available facilities in the world, which are being used for recovery of ferrous and non-ferrous metals have been described in terms of geographically distributed facilities and integrated facilities.

An example of geographically distributed 3<sup>rd</sup> level E-waste treatment facility has been described by an environmentally complying operation of such facility in North America. The salient features of this operation are given below.

1. Approximately 50% of the output from recycling plants is shipped copper smelter and the balance (mainly steel and aluminum) is shipped to its approved facilities for smelting and refining.
2. The recycler has two plants; one focused on sampling and preparation of copper and precious metals from E-waste fractions, which is sent for final recovery at the smelter/refinery.
3. At the sampling facility circuit boards and other E-waste residues after second level of treatment are prepared for smelting, sampled and assayed for precious metal content.

4. The assayed material is then sent to copper smelter. Precious metals are recovered at the copper smelter through three stages of refinement; the reactor, the converters, and the anode furnaces, which produce 99.1% pure copper.
5. Precious metals are recovered at other facility, where precious metals and copper alloyed in the anode product are leached, smelted and refined through electrolysis to separate copper from precious metals.

Example of an integrated 3<sup>rd</sup> level E-waste treatment facility has been described by an environmentally complying operation of such facility in Europe. The specific process followed by the recycler is given at **Annexure – XI**.

## Chapter 7

### **GUIDELINES FOR ESTABLISHMENT OF INTEGRATED E-WASTE RECYCLING & TREATMENT FACILITY**

Guidelines for establishment of E-waste Recycling & Treatment Facility shall be in line with the existing Guidelines/best practices/requirements in India for establishing and operating “Recycling and Treatment and Disposal Facilities” for hazardous wastes. Such facilities shall be set up in the organized sector. However, the activities presently operating in the informal sector need to be upgraded to provide a support system for the integrated facility. This would enable to bring the non-formal sector in the main stream of the activity and facilitate to ensure environmental compliances. The proposed mechanism for the e-waste facility is only an illustrative model and details have to be worked out to develop such facilities.

#### **7.1 Facility Operation Requirements**

- **Collection**
- **Storage**
- **Dismantling & Segregation**
- **Recycling**
- **Treatment & Disposal**

##### **7.1.1 Collection Systems for e-waste**

A producer is responsible for his products he may be involved in the establishment of the take back system for end of use electronic and electrical equipments. The producer responsibility could be either Individual or collective. Individual model requires each producer to be responsible for managing the e-waste generated by their products. The producer shall announce a take back system. The individual producers can have direct contact with dismantlers or recyclers which allows them to get back the re-usable components from their obsolete equipments. The producers can also get the data from the collector/dismantler/recycler about the specific composition and characteristics of the products. In the case of collective producer responsibility the producer would enter into a contractual agreements with a collection agency which would be responsible for collection of the waste from the generator. The producers through the collection agency have to pay a fixed price for their products to the generator, as in the collective responsibility model. The take back system may provide free collection or provide discount on purchase of new items. This facilitates in establishing a feasible and effective collection system to enable the channelization of the e-waste to appropriate recycling facilities and increasing re-use of certain components. The economic rationale behind is to facilitate the transfer of the benefits to the consumers enabling them to get better price on the sale of used equipments.

### 7.1.2 Storage areas

- (1) The storage areas for storing the e-waste in a facility can be located within the facility - **on-site storage** or located at a place outside the facility - **off-site storage** including the warehouses. Such storage areas should be covered areas for storage of e-waste till such time that the waste is recycled or treated. The storages could also be the warehouses hired for this purpose.
- (2) Appropriate containers should be used for storing different e-waste items separately and there should be no mixing of different kinds of e-waste
- (3) The purpose of the weatherproof covering for storage at treatment sites is to minimize the contamination of clean surface and rain waters, to facilitate the reuse of those whole appliances and components intended for recycling and to assist in the containment of hazardous materials and fluids. The areas that are likely to require weatherproof covering will therefore include the storage areas and the treatment areas for the treating hazardous or fluid containing e-waste or whole appliances or components intended for recycling. The type of weatherproof covering required will depend of the types and quantities of waste and the storage and treatment activities undertaken. Weatherproof covering may in some circumstances simply involve a lid or cover over a container but in others it may involve the construction of a roofed building.
- (4) Impermeable surfaces should be provide for appropriate areas. "Impermeable surface" means a surface or pavement constructed and maintained to a standard sufficient to prevent the transmission of liquids beyond the pavement surface. The impermeable surface should be associated with a sealed drainage system and may be needed even where weatherproof covering is used. This means a drainage system with impermeable components which does not leak and which will ensure that no liquid will run off the pavement other than via the system and all liquids entering the system are collected in a sealed sump.
- (5) Appropriate spillage collection facilities should be provided. The spillage collection facilities include the impermeable pavement and sealed drainage system as the primary means of containment. However, spill kits to deal with spillages of oils, fuel and acids should be provided and used as appropriate.
- (6) Appropriate sites must provide appropriate storage for disassembled spare parts. Some spare parts (e.g. motors and compressors) will contain oil and/or other fluids. Such parts must be appropriately segregated and stored in containers that are secured such that oil and other fluids cannot escape from them. These containers must be stored on an area with an

impermeable surface and a sealed drainage system.

- (7) Other components and residues arising from the treatment of e-waste will need to be contained following their removal for disposal or recovery. Where they contain hazardous substances they should be stored on impermeable surfaces and in appropriate containers or bays with weatherproof covering. Containers should be clearly labeled to identify their contents and must be secure so that liquids, including rainwater, cannot enter them. Components should be segregated having regard to their eventual destinations and the compatibility of the component types. All batteries should be handled and stored having regard to the potential fire risk associated with them.

### **7.1.3 Dismantling & Segregation of dismantled parts**

- (1) Dismantling and segregation of e-waste are the first steps towards recycling of the e-waste. These are cost effective and labour intensive activities that are mostly carried out in the informal sector which needs to be brought into the mainstream recycling activity. Such activities may be retained with the existing dismantling units to become a feeder system for the Integrated Facility or provisions could be made in the integrated facility for setting up a shed for dismantling and segregation.
- (2) Dismantling of e-waste may be carried out manually or mechanically depending upon the scale of operations and the e-waste being handled. Manual Dismantling should only involve the of used electronic and electrical equipments where there is no likelihood for being in contact with hazardous substances. An integrated facility should provide a mechanical dismantling facility to dismantle e-waste containing hazardous substances.

### **7.1.4 Recycling**

- (1) Recycling of e-waste comprises of various stages with options of technologies available for recycling the various components of e-waste which may be referred to in Chapters 5 & 6.
- (2) The integrated e-waste recycling facility should opt for the Best Available Technologies (BAT) and provide the state of the art facility complying with all the environmental norms in the terms of emissions, effluents, noise waste treatment and disposal etc.

### **7.1.5 Treatment & Disposal**

- (1) Provisions should be made of equipment for the treatment of water, including rainwater, in compliance with health and environmental regulations. However, it should be remembered that as a matter of best

practice, operators of treatment facilities should take appropriate steps to minimize the contamination of clean waters. All liquid runoff from an impermeable pavement used for the treatment of hazardous e-waste and hazardous components will be regarded as being contaminated, unless it can be shown otherwise (irrespective of whether there happens to be any activity on the pavement at the time.)

- (2) On most sites, two systems for the management of water will be necessary, for clean water and for contaminated water. Clean water can be dealt with by surface water drains that should carry only uncontaminated water from roofs to a watercourse or soak away. The treatment of contaminated water to the necessary standard will require a sealed drainage system, as defined above. It may be necessary to obtain consent if water is to be discharged.
- (3) Impermeable surfaces should be provided for appropriate areas. "Impermeable surface" means a surface or pavement constructed and maintained to a standard sufficient to prevent the transmission of liquids beyond the pavement surface. The impermeable surface should be associated with a sealed drainage system and may be needed even where weatherproof covering is used. This means a drainage system with impermeable components which does not leak and which will ensure that no liquid will run off the pavement other than via the system and all liquids entering the system are collected in a sealed sump.
- (4) The activity of treating e-waste itself carries a risk of pollution that must be managed. All treatment activities must take place within an area provided with an impermeable surface. The type of impermeable surface required is likely to depend on a number of factors, including:
  - type and quantity of e-waste being processed
  - whether it contains hazardous substances and fluids
  - type and volume of other materials dealt with
  - type and level of activity undertaken on the surface
  - length of time the surface is meant to be in service
  - level of maintenance

Whether a surface is in fact impermeable will depend on how it is constructed and the use it is put to. A surface will not be impermeable and therefore will be unacceptable if, it has slabs or paving not properly joined or sealed, it is composed solely of hard standing made up of crushed or broken bricks or other types of aggregate and spillages or surface water will not be contained within the system.

- (5) Spillage collection facilities include the impermeable pavement and sealed drainage system as the primary means of containment. However, spill kits to deal with spillages of oils, fuel and acids should be provided and used as appropriate.



- (6) Records to be maintained on the treated waste to ensure that e-waste entering a treatment facility and components and materials leaving each site (together with their destinations).
- (7) Operators of treatment facilities need to be aware that there will be a data reporting requirement placed on them. The emphasis will be on obligated producers to report compliance, and in this context they should engage ATFs that provide treatment compliance services to ensure they can show adequate verification of treatment for the e-waste for which they have responsibility.

## **7.2 Procedures for Setting-up & Management of integrated e-waste facility.**

For any processing and recycling facilities that receive designated materials, it must be ensured that:

1. Facilities are fully licensed by all appropriate governing authorities. The degree of licensing necessary will vary depending upon the particular jurisdiction, as well as the size and nature of the facility.
2. Necessary Environmental Clearances (EC) should be obtained based on the scale of operations as prescribed in the Environmental Clearance notification dated 14 September 2006.
3. Facilities should have an Environmental Management System (EMS) in place.
4. Facility should be registered as a Recycler under the Hazardous Wastes (Management and Handling) Rules 2003 with the Central Pollution Control Board.
5. Facility should have obtained consents under the Water Pollution (Control & Prevention) Act, 1974 and Air Pollution (Control & Prevention) Act, 1981.
6. A facility has a written plan describing the facility's risk management objectives for environmental performance and compliance and its plans for attaining these objectives based on a "plan-do-check-act" continual improvement model.
7. Regular re-evaluation of Environment, Health and Safety (EHS) objectives and monitoring of progress toward achievement of these objectives is conducted and documented at all facilities.
8. Facilities take sufficient measures to safeguard occupational and environmental health and safety. Such measures may be indicated by local, state, national and international regulations, agreements, principles and

standards, as well as by industry standards and Guidelines. Except as noted below, such measures for all facilities include:

- EH&S training of personnel.
  - An up-to-date, written hazardous materials identification and management plan that specifically addresses at least the following: lead, mercury, beryllium, cadmium, batteries, toner, phosphor compounds, PCBs, and brominated flame retardants and other halogenated materials, with particular focus on possible generation of by-product dioxins and furans.
  - Where materials are shredded or heated, appropriate measures to protect workers, the general public and the environment from hazardous dusts and emissions. Such measures include adaptations in equipment design or operational practices, air flow controls, personal protective devices for workers, pollution control equipment or a combination of these measures.
  - An up-to-date, written plan for reporting and responding to exceptional pollutant releases, including emergencies such as accidents, spills, fires, and explosions.
  - Liability insurance for pollutant releases, accidents and other emergencies.
  - Completion of an EH&S audit, preferably by a recognized independent auditor, on an annual basis. However, for small businesses, greater flexibility may be needed, and an audit every three years may be appropriate.
9. Facilities have a regularly-implemented and documented monitoring and recordkeeping program that tracks key process parameters, compliance with relevant safety procedures, effluents and emissions, and incoming, stored and outgoing materials and wastes.
10. Facilities have an adequate plan for closure. The need for closure plans and financial guarantees is determined by applicable laws and regulations, taking into consideration the level of risk. Closure plans should be updated periodically, and financial guarantees should ensure that the necessary measures are undertaken upon definite cessation of activities to prevent any environmental damage and return the site of operation to a satisfactory state, as required by the applicable laws and regulations.

### **7.3 Procedures for compliance with the existing regulations and Guidelines**

1. Existing Indian Guidelines/ best practices/ requirements for establishment and operation of storage, treatment, and disposal facilities for hazardous wastes may be adequate for establishing and operating Integrated E-waste Management

Facility (IEWMF). This will minimize interventions in existing regulatory institutional mechanism related to pollution prevention, abatement and control.

2. Permission needs to be given to Secured Landfilling and incineration solely for e-waste Residues Treatment
3. Plastic containing flame retardants can be burnt in common hazardous waste incineration facilities. But monitoring and control of plastic burning at these facilities is a big environmental health and safety issue. Therefore, plastic, which cannot be recycled and is hazardous in nature is recommended to be landfilled in nearby TSDF/SLF.
4. CFCs shall be handled as per the Montreal Protocol.

***(The provisions for disposal of CFCs laid out in the Montreal Protocol are available at the UNEP website i.e. <http://www.unep.org/ozone/montreal>. The Handbook for Montreal Protocol on substances that deplete the Ozone layer Seventh Edition (2006) is available on web site i.e. <http://www.unep.ch/ozone/index.shtml> )***

5. Used Oil needs to be disposed out as per Hazardous Waste Management Rules, 2003.

***(The provisions of rules for disposal of used oil is available at CPCB's web site i.e. [http://www.cpcb.nic.in/Hazardous%20Waste/default\\_Hazardous\\_Waste.html](http://www.cpcb.nic.in/Hazardous%20Waste/default_Hazardous_Waste.html))***

6. Capacitors containing PCB's can be incinerated in common hazardous waste incineration facilities.
7. Existing Lead recycling facilities from batteries fall under the existing environmental regulations for air, water, noise, land and soil pollution and generation of hazardous waste. In case lead recovery is very low, they can be temporarily stored at e-waste dismantling facility and later disposed in TSDF.

***(The provisions of rules for disposal of lead acid battery plates is available at CPCB's web site i.e. [http://www.cpcb.nic.in/Hazardous%20Waste/default\\_Hazardous\\_Waste.html](http://www.cpcb.nic.in/Hazardous%20Waste/default_Hazardous_Waste.html))***

8. Mercury recovery facilities using distillation process in India fall under the existing environmental regulations for air, water, noise, land and soil pollution and generation of hazardous waste. In case mercury recovery from e-waste is very low, they can be temporarily stored at e-waste dismantling facility and later disposed in TSDF.
9. There is a need for collection and transportation system for e-waste. This will also ensure availability of e-waste to IEWMF. An organization consisting of industries or industry association at national and local level can be made responsible for collection and transportation of e-waste. Such type of organizations is functional in e-waste management system outside India. They act as important link between e-waste generator and dismantler. But in the

absence of such organization, the e-waste treatment facility operator will integrate backward with generators, which will have higher cost implications.

### **General Suggestions**

1. The land for e-waste treatment facility shall be provided on the similar lines as for the TSD facility by the State Government.
2. Land cost constitutes about 25% to 30% of total capital cost, which is very significant. This cost can be reduced if respective state government provides long term lease as its contribution to an operator. Further, if the available land is not suitable as per commercial or from environmental point of view, the state government should provide some financial incentive like difference in commercial rate and government rate. This will catalyze and speed up establishment of IEWMF.
3. CRT breaking and glass recycling is being practiced in organized sector in India. These facilities fall under the purview of existing environmental regulations for air, water, noise, land and soil pollution and generation of hazardous waste. Lead either joins the recycling stream or can be disposed off in TSD facility.
4. Existing ferrous and non ferrous metal recycling facilities fall under the purview of existing environmental regulations for air, water, noise, land and soil pollution and generation of hazardous waste.
5. The equipment used in dismantling facility is recommended to be covered under pollution control equipment so that the treatment facility can charge 100% depreciation in the first year. This will improve financial viability of the e-waste facility.
6. The complete recycling of e-waste including the Metal Recovery should be promoted for setting-up of IEWMF.
7. Concept of Extended Producer Responsibility can be thought off in the Indian Context.

## **International Scenario**

### **Basel Convention**

Basel Convention covers all discarded/disposed materials that possess hazardous characteristics as well as all wastes considered hazardous on a national basis. Annex VIII, refers to e-waste, which is considered hazardous under Art. 1, par. 1(a) of the Convention: A1180 Waste electrical and electronic assemblies or scrap containing components such as accumulators and other batteries included on list A, mercury-switches, glass from cathode-ray tubes and other activated glass and PCB-capacitors, or contaminated with Annex I constituents (e.g., cadmium, mercury, lead, polychlorinated biphenyl) to an extent that they possess any of the characteristics contained in Annex III. Annex IX, contains the mirror entry, B1110 Electrical and Electronic assemblies given below.

- Electronic assemblies consisting only of metals or alloys
- Waste electrical and electronic assemblies or scrap (including printed circuit boards) not containing components such as accumulators and other batteries included on List A, mercury-switches, glass from cathode-ray tubes and other activated glass and PCB-capacitors, or not contaminated with Annex 1.

### **OECD**

#### ***OECD (2001)***

WEEE / E-waste have been defined as “any appliance using an electric power supply that has reached its end-of-life.”

### **Other Countries**

#### **European Union (EU)**

Definition as per EU directive has been described below. Countries, which have transposed this definition into their national legislations are Austria, Belgium, Cyprus, Czech Republic, Denmark, Estonia, Finland, France, Germany, Greece, Hungary, Ireland, Italy, Latvia, Lithuania, Luxembourg, The Netherlands, Norway, Poland, Portugal, Slovakia, Slovenia, Spain, Sweden, Switzerland and United Kingdom.

#### **WEEE Directive (EU, 2002a)**

“Electrical or electronic equipment which is waste including all components, sub-assemblies and consumables, which are part of the product at the time of discarding.” Directive 75/442/EEC, Article 1(a) defines “waste” as “any substance or object which

the holder disposes of or is required to dispose of pursuant to the provisions of national law in force.”

(a) ‘electrical and electronic equipment’ or ‘EEE’ means equipment which is dependent on electrical currents or electromagnetic fields in order to work properly and equipment for the generation, transfer and measurement of such current and fields falling under the categories set out in Annex IA to Directive 2002/96/EC (WEEE) and designed for use with a voltage rating not exceeding 1000 volts for alternating current and 1500 volts for direct current.

Further EU Directives 2002/95/EC of 27 January 2003 on the restriction of the use of certain hazardous substances in electrical and electronic equipments has also come into force w.e.f January 2007. These directives provide for the reduction and elimination of hazardous substances used in electrical and electronic equipments.

Categories of WEEE covered under these directives are as follows :

### **WEEE Directive (EU, 2002a)**

#### **Annex IA**

Categories of electrical and electronic equipment covered by this Directive

1. Large household appliances
2. Small household appliances
3. It and telecommunications equipment
4. Consumer equipment
5. Lighting equipment
6. Electrical and electronic tools (with the exception of large-scale stationary industrial tools)
7. Toys, leisure and sports equipment
8. Medical devices (with the exception of all implanted and infected products)
9. Monitoring and control instruments
10. Automatic dispensers

#### **Annex IB**

List of products, which fall under the categories of Annex IA are given below.

##### **1. Large household appliances**

Large cooling appliances

Refrigerators

Freezers

Other large appliances used for refrigeration, conservation and storage of food

Washing machines

Clothes dryers  
Dish washing machines  
Cooking  
Electric hot plates  
Microwaves  
Other large appliances used for cooking and other processing of food  
Electric heating appliances  
Electric radiators  
Other fanning, exhaust ventilation and conditioning equipment

## 2. Small household appliances

Vacuum cleaners  
Carpet sweepers  
Other appliances for cleaning  
Appliances used for sewing, knitting, weaving and other processing for textiles  
Iron and other appliances for ironing, mangling and other care of clothing  
Toasters  
Fryers  
Grinders, coffee machines and equipment for opening or sealing containers or packages  
Electric knives  
Appliances for hair-cutting, hair drying, tooth brushing, shaving, massage and other body care appliances  
Clocks, watches and equipment for the purpose of measuring indicating or registering time Scales.

## 3. IT and Telecommunications equipment

Centralised data processing  
Mainframes  
Minicomputers  
Printer units  
Personal computing:  
Personal computers (CPU, mouse, screen and keyboard included)  
Laptop computer (CPU, mouse, screen and keyboard included)  
Notebook computers  
Notepad computers  
Printers  
Copying equipment  
Electrical and electronic typewriters  
Pocket and desk calculators  
And other products and equipment for the collection, storage, processing, presentation or communication of information by electronic means  
User terminals and systems  
Facsimile

Telex  
Telephones  
Pay telephones  
Cordless telephones  
Cellular telephones  
Answering systems  
And other products or equipment of transmitting sound, images or other information by telecommunications

#### 4. Consumer equipment

Radio sets  
Television sets  
Video cameras  
Video recorders  
Hi-fi recorders  
Audio amplifiers  
Musical instruments  
And other products or equipment for the purpose of recording or reproducing sound or image, including signals or other technologies for the distribution of sound and image than by telecommunications

#### 5. Lighting equipment

Luminaries for fluorescent lamps with the exception of luminaries in households  
Straight fluorescent lamps  
Compact fluorescent lamps  
High intensity discharge lamps, including pressure sodium lamps and metal lamps  
Low pressure sodium lamps  
Other lighting or equipment for the purpose of spreading or controlling light with the exception of filament bulbs

#### 6. Electrical and electronic tools (with the exception large-scale stationary industrial tools)

Drills  
Saws  
Sewing machines  
Equipment for turning, milling, sanding, grinding, sawing, cutting, shearing, drilling, making, holes, punching, folding, bending or similar processing of wood, metal and other materials  
Tools for riveting, nailing or screwing or removing rivets, nails, screws or similar uses  
Tools for welding, soldering or similar use  
Equipment for spraying, spreading, dispersing or other treatment of liquid or gaseous substances by other means  
Tools for mowing or other gardening activities



## 7. Toys, leisure and sports equipment

- Electric trains or car racing sets
- Hand-held video game consoles
- Video games
- Computers for biking, diving, running, rowing, etc.
- Sports equipment with electric or electronic components
- Coin slot machines

## 8. Medical devices (with the exception of all implanted and infected products)

- Radiotherapy equipment
- Cardiology
- Dialysis
- Pulmonary ventilators
- Nuclear medicine
- Laboratory equipment for in-vitro diagnosis
- Analysers
- Freezers
- Fertilization tests
- Other appliances for detecting, preventing, monitoring, treating, alleviating illness, injury or disability

## 9. Monitoring and control instruments

- Smoke detector
- Heating regulators
- Thermostats
- Measuring, weighing or adjusting appliances for household or as laboratory equipment
- Other monitoring and control instruments used in industrial installations (e.g. in control panels)

## 10. Automatic dispensers

- Automatic dispensers for hot drinks
- Automatic dispensers for hot or cold bottles or cans
- Automatic dispensers for solid products
- Automatic dispensers for money
- All appliances which deliver automatically all kind of products

## Canada

Canada's WEEE/ E-waste regulations are in the process of being developed at provincial level. Alberta, Saskatchewan, British Columbia, Ontario and Nova Scotia have WEEE/ E-waste regulations in place.

The details of the regulations of each province are as follows:

### **E-waste definition in *Canada***

Canada's WEEE/ E-waste regulations are in the process of being developed at provincial level. Alberta, Saskatchewan, British Columbia, Ontario and Nova Scotia have WEEE/ E-waste regulations in place. The WEEE/ E-waste definitions or statements as per these regulations are given below.

#### ***Alberta***

Electronics Designation Regulation A.R.94/2004 published on May 12, 2004 enforced from October 1, 2004 as Appendix to Environmental Protection and Enhancement Act defines "Electronics" as all electrical and electronic equipment or devices, whether intended for consumers, industrial or commercial use, and includes, without limitation,

- Television
- Computers, laptops and notebooks, including CPUs, keyboards, mouse, cables and other components in the computer
- Computer monitors
- Computer printers, including printers that have scanning or fax capabilities, or both
- Scanners
- Audio and video playback and recording systems
- Telephones and fax machines
- Cell phones or other wireless devices and
- Electronic game equipment, but does not include electronics contained within and affixed to a motor vehicle

Electronics has been defined as designated material for the purpose of Part 9, Division 1 of the Act and the "Designated Material Recycling and Management Regulation". The term used instead of WEEE/E-waste is "Disposal of Electronics" under this regulation.

#### ***British Columbia***

Schedule 3,"Electronic Product Category" was included in "British Columbia Recycling Regulation" dated October 7, 2004 as amended on February 16, 2006. The electronic product category consists of "Computers" that are designed for desktop use by an individual, for desktop use as a server or to be portable, except hand held devices, "Desktop Printers" and "Televisions". The electronic product category does not include computers and televisions that are part of or attached to vehicles, marine vessels or commercial or industrial equipment.

Computers include a computer monitor and computer peripheral. Computer peripheral means a keyboard, mouse or cable that attaches or is attached to a computer. Desktop printer means a printer that will print on paper not exceeding 8.5 inches in width but

does not include a label printer.

“British Columbia Stewardship Plan for End-of-Life Electronics”, a plan formulated in response to the above regulation defines WEEE/ E-waste as “End of Life” electronics where electronics means the electronic product category mentioned above.

### ***Nova Scotia***

“Solid Waste-Resource Management Regulations” made under Section 102 of the Environment Act as amended on February 22,2007 mentions “Electronic Products Stewardship Program” in Part II. “Electronic Product” means an electrical device or electronic equipment that is a designated material. “Designated Material” has been defined as materials listed in Column 1 of Schedule “B” and includes following electronic items.

- Televisions
- Desktop, laptop and notebook computers, including CPU's, keyboards, mice, cables and other components in the computer
- Computer monitors
- Computer printers, including printers that have scanning or fax capabilities or both
- Computer scanners
- Audio and video playback and recording systems
- Telephones and fax machines
- Cell phones and other wireless devices

“Electronic Product Stewardship Program” means a program that establishes a process for collection, transportation, reuse and recycling of electronic products and, if no further options exist, the disposal of any residual electronic product components and incorporates the principles of a pollution prevention hierarchy by replacing disposal with reuse and recycling of electronic products.

### ***Ontario***

The Waste Electronic and Electrical Equipment (WEEE) regulation under the *Waste Diversion Act, 2002* (WDA) was filed on December 14, 2004. The regulation designates seven categories of electronic and electrical equipment as waste, and targets more than 200 items that could be designated, including computers, telephones, broadcast equipment, televisions and CD players, children's toys, power tools, lawn mowers and navigational and medical instruments. Products targeted under Ontario WEEE legislation are given in below.

**Table : Products Designated under Ontario Legislation**

<b>Priority Categories</b>	<b>List of WEEE Products</b>	
Household Appliances	<ul style="list-style-type: none"> <li>• Air conditioners</li> <li>• Clothes dryers</li> <li>• Clothes washers</li> <li>• Dishwashing machines</li> </ul>	<ul style="list-style-type: none"> <li>• Freezers</li> <li>• Refrigerators</li> <li>• Stove</li> </ul>
IT Equipment	<ul style="list-style-type: none"> <li>• CD-ROM and disk drives</li> <li>• Computers (desktop, handheld, laptop, notebook, notepad)</li> <li>• Monitors (CRT, LCD, plasma)</li> </ul>	<ul style="list-style-type: none"> <li>• PDAs</li> <li>• Keyboard, mouse, terminals</li> <li>• Printers, copiers, typewriters</li> </ul>
Telecommunications equipment	<ul style="list-style-type: none"> <li>• Fax/telephone answering machine</li> <li>• Modems</li> </ul>	<ul style="list-style-type: none"> <li>• Pagers</li> <li>• Telephones (cell, cordless, wire)</li> </ul>
Audio-Visual Equipment	<ul style="list-style-type: none"> <li>• Sound equipment</li> <li>• Cameras</li> </ul>	<ul style="list-style-type: none"> <li>• Televisions</li> <li>• Video player, projector, recorder</li> </ul>

### **Saskatchewan**

“The Waste Electronic Equipment Regulations” filed on October 13, 2005 under The Environmental Management and Protection Act, 2002, defines WEEE/ E-waste as “waste electronic equipment”, which means electronic equipment that the consumer no longer wants.

“Electronic Equipment” means any electronic equipment listed in Column 1 of Table 1 of these regulations. This table includes following electronic equipment

- Personal desktop computer, including the central processing unit and all other parts contained in the computer
- Personal notebook computer, including the central processing unit and all other parts contained in the computer
- Computer monitor, including cathode ray tube, liquid crystal display and plasma,
- Computer mouse, including cables
- Computer printer including dot matrix; ink jet; laser; thermal and computer printer with scanning or facsimile capabilities or both
- Television (cathode ray tube, liquid crystal display, plasma and rear projection)

### **Japan**

There is no specific definition of WEEE/ E-waste as defined in the regulatory system.

E-waste is covered under laws to promote recycling within Japan. The two major laws covering broad range of E-waste items are “The Law for Recycling of Specified Kinds of Home Appliances (Home Appliances Recycling Law)” enacted in 1998 and “The Law for Promotion of the Effective Utilization of Resources” enacted in 2000.

In “The Law for Recycling of Specified Kinds of Home Appliances (Home Appliances Recycling Law)”, E-waste is referred as “Used Consumer Electric Goods Discarded by Consumers”. This law covers TVs, Refrigerators, Washing Machines and Air Conditioners.

In “The Law for Promotion of the Effective Utilization of Resources”, E-waste is covered under “Used goods and by-products” which have been generated and their large part is discarded. This law covers personal computers (home and office) and other electronic items. According to this law “Used goods” means any articles that are collected, used or unused, or is disposed of (except radioactive materials or those contaminated thereby). “By-product” means any articles obtained secondarily in the process of manufacturing, processing, repair or sale of the product; in the process of supply of energy; or in the process of construction pertaining to architecture and civil engineering (hereinafter referred to as “construction work”) except radioactive materials or those contaminated thereby.

## **USA**

According to USEPA, Electronic products that are “near” or at the “end of their useful life” are referred to as “e-waste” or “e-scrap.” Recyclers prefer the term “e-scrap” since “waste” refers only to what is left after the product has been reused, recovered or recycled. However, “E-waste” is the most commonly used term.

In developed countries, currently, it equals 1% of total solid waste generation and is expected to grow to 2% by 2010. In USA, it accounts 1% to 3% of the total municipal waste generation. In EU, historically, e-waste is growing three times faster than average annual municipal solid waste generation. A recent source estimates that total amount of e-waste generation in EU ranges from 5 to 7 million tonnes per annum or about 14 to 15 kg per capita and is expected to grow at a rate of 3% to 5% per year. In developing countries, it ranges 0.01% to 1% of the total municipal solid waste generation. In China and India, though annual generation per capita is less than 1 kg, it is growing at an exponential pace.

## HAZARDOUS SUBSTANCES THAT CAN OCCUR IN E-WASTE

S.No.	Hazardous Substance	Use	Risk	Regulatory requirements with threshold quantities
1.	Short Chain Chloro Paraffins, Alkanes, C <sub>10-13</sub>	Amounts less than 1% by weight of SCCP are present in mid chain chlorinated paraffin's (MCCP). Used as secondary plasticizer and flame retardant for PVC and chlorinated rubber in cable insulation	Very toxic to aquatic organisms. It may cause long term effects in the aquatic environment.	Halogenated Aliphatic Compounds Covered under schedule 2, B11  ≥0.5%
2.	Antimony trioxide	The major use is as a flame retardant synergist in plastics etc. It increases the flame retardant effectiveness of halogenated flame retardant compounds thereby minimizing their level.	Limited evidence of a carcinogenic effect	Antimony and antimony compounds Covered under Schedule 2 as A1 ≥0.005%
3	Beryllium metal	Chassis, rotating mirrors in laser printers; windows for X-ray generators and detectors for research and medical purposes. Benefits of use include: Low density; high stiffness; high specific heat and lightweight rigidity for precision instrumentation.	Very toxic on inhalation. It may cause cancer by inhalation. Beryllium component scrap is classified as non-hazardous in the OECD, Basel and EU regime. However, it is recommended that beryllium metal components should be segregated from equipment at end-of-life and returned to the supplier for recycling.	Beryllium and cadmium compounds Covered under Schedule 2 as A3  ≥0.005%
4	Beryllium oxide (Beryllia)	Used in heat sink electrical insulators for electrical and electronic systems and devices. It has the benefits of very high thermal conductivity; very high electrical resistivity; low dielectric constant; low loss factor; high breakdown voltage; and chemically inert. Beryllium ceramic components should be separated from equipment at end-of-life and returned to the supplier for recycling. Beryllia components should not be passed through crushing and shredding operations without proper controls, due to the risk of dust generation. Beryllia ceramic component scrap is classified as non-hazardous in the OECD, Basel and EU Waste control Systems.	Very toxic by inhalation. It may cause cancer by inhalation	Beryllium and cadmium compounds Covered under Schedule 2 as A3 ≥0.005%

S.No.	Hazardous Substance	Use	Risk	Regulatory requirements with threshold quantities
4	Beryllium oxide (Beryllia)	<p>Used in heat sink electrical insulators for electrical and electronic systems and devices..</p> <p>Beryllium ceramic components should be separated from equipment at end-of-life and returned to the supplier for recycling. Beryllia components should not be passed through crushing and shredding operations without proper controls, due to the risk of dust generation.</p> <p>Beryllia ceramic component scrap is classified as non-hazardous in the OECD, Basel and EU Waste control Systems.</p>	<p>Very toxic by inhalation. It may cause cancer by inhalation</p>	<p>Beryllium and cadmium compounds</p> <p>Covered under Schedule 2 as A3</p> <p><math>\geq 0.005\%</math></p>
5	Cadmium	<p>Cadmium metal or powder may be used as part of the negative electrode material in nickel-cadmium (NiCd) batteries, as an electrodeposited, vacuum deposited or mechanically deposited coating on iron, steel, aluminium-base materials, titanium-base alloys or other non-ferrous alloys, and as an alloying element in low-melting brazing, soldering and other specialty alloys.</p>	<p>Very toxic by inhalation. It may cause cancer.</p> <p>Harmful to aquatic organisms</p>	<p>Cadmium and Beryllium compounds Covered under Schedule 2 as A4</p> <p><math>\geq 0.005\%</math></p>
6	Cadmium oxide	<p>Cadmium oxide is utilized most often as part of the negative cadmium electrode in nickel-cadmium and some silver-cadmium military batteries. Cadmium oxide is also part of silver-cadmium oxide (ag-CdO) electrical contact alloys.</p>	<p>May cause cancer by inhalation.</p> <p>Toxic by inhalation. Toxic if swallowed. Danger of serious damage to health by prolonged exposure</p> <p>Harmful if swallowed</p>	<p>Cadmium and Beryllium compounds Covered under Schedule 2 as A4</p> <p><math>\geq 0.005\%</math></p>

S.No.	Hazardous Substance	Use	Risk	Regulatory requirements with threshold quantities
7	Cadmium sulphide	Cadmium sulphide serves as the basis compound for a series of pigments and semiconducting compounds with a wide range of uses. Apart from its use in red, orange and yellow pigments for plastics, glasses, ceramics, enamels and artists colours, cadmium sulphide is also used for phosphors in x-ray fluorescent screens, cathode ray tubes and electronic devices; smoke alarm photoreceptors; photographic exposure meters; and photovoltaic energy conversion systems.	Limited evidence of a carcinogenic effect Toxic by inhalation. Toxic if swallowed. Danger of serious damage to health by prolonged exposure Harmful if swallowed. It may cause long term effects in the aquatic environment.	Cadmium and Beryllium compounds Covered under Schedule 2 as A4  ≥0.005%
8	Chromium VI	Used as colorant in pigments (e.g. lead chromate) and as corrosion inhibitor (sodium dichromate) in circulating water systems e.g. absorption heat pumps and (industrial) heat exchangers in freezers and refrigerators. Chromium (VI) has historically been used by the electronics industry as an anti-corrosion treatment, as well as an electrical shielding material for certain sheet metals <sup>29</sup> .	Toxic if swallowed/very very toxic by inhalation. It may cause heritable genetic damage. It may cause cancer by inhalation. Very toxic to aquatic organisms and may cause long term effects in the aquatic environment.	Chromium (VI) compounds Covered under Schedule 2 as A5  ≥0.005%
9	Copper beryllium alloys	Used in electrical connector terminations; switch components; relay springs; electromagnetic radiation seals.	Components in end-of-life electrical equipment can be recycled as part of the general copper recycle stream. There is generally no need for component extraction prior to equipment recycling.  Toxic by inhalation	Beryllium and Beryllium compounds covered under Schedule 2 as A3  ≥0.005%



S.No.	Name	Usage	Substance Risk	Regulatory requirements with threshold quantities
10	Decabromodiphenylether (DBDE)	Used as a flame retardant in electrical and electronic plastics.	Potential for forming brominated dibenzodioxins or furans (PBDD/F) in uncontrolled thermal processes, and possibility that higher PBDEs could debrominate to form the tetra and penta BDEs found in marine environment food chain	Halogenated Compounds of Aromatic Rings covered under Schedule 2 as A16  ≥0.005%
11	Lead	Used in batteries, solders, alloying element for machining metals, printed circuit boards, components, incandescent light bulbs, and weighting	Processing of metallic lead may give rise to lead compounds, which are all, classified as dangerous substances. The land filling of WEEE has given rise concerns over possible leaching of lead into the environment.	Lead and Lead compounds covered under Schedule 2 as B4  ≥0.5%
12	Lead oxide	Occurs in leaded glass in cathode ray tubes, light bulbs and photocopier pastes. Lead oxide is also used in batteries.	May cause harm to the unborn child Harmful by inhalation/harmful if swallowed	Lead and Lead compounds covered under Schedule 2 as B4  ≥0.5%

S.No.	Name	Usage	Substance Risk	Regulatory requirements with threshold quantities
13	Liquid Crystals: Commercially available liquid crystals (LC) are mixtures of 10 to 20 substances, which belong to the group of substituted phenylcyclohexanes, alkylbenzenes and cyclohexylbenzenes. The chemical substances contain oxygen, fluorine, hydrogen and carbon. About 250 chemical substances are used for formulating more than thousand marketed liquid crystals.	Liquid crystal mixture are used as electroactive layer in liquid crystal display (LCD). Today LCDs are a widely used components in electric and electronic (E&E) products as i.e. mobile phones, notebooks, automotive displays, electronic games, PC monitors, etc.	Press articles claiming that LCDs contain carcinogenic azo-dyes. More current articles talk about hazardous ingredients. Toxicological studies on a large number of single liquid crystals have been performed according to OECD Guidelines and EU regulation. SO far no indications of carcinogenic potential and acute oral toxicity have been found.	Not covered under schedule 1 and 2
14	Mercury	It is estimated that 22 % of the yearly world consumption of mercury is used in electrical and electronic equipment. It is basically used in thermostats, (position) sensors, relays and switches (e.g. on printed circuit boards and in measuring equipment) and discharge lamps. It is used in data transmission, telecommunications, mobile phones batteries, and certain lightsources <sup>30</sup> .	Very toxic to aquatic organisms and may cause long term effects in the aquatic environment. Effects in humans are mainly affecting the central nervous system effects (CNS) as well as the kidney. Toxic by inhalation	Mercury and mercury compounds covered under Schedule 2 as A6  >=0.005%
15	Mineral Wool: [Man-made vitreous (silicate) fibers with random orientation with alkaline oxide and alkali earth oxide (Na <sub>2</sub> O+K <sub>2</sub> O+CaO+MgO+BaO) content greater than 18 % by weight]		Limited evidence of carcinogenic effect  Irritating to the skin	Not covered under schedule 1 and 2

S.No.	Name	Usage	Substance Risk	Regulatory requirements with threshold quantities
16	Octabromodiphenylether (OBDE)	Flame retardant in plastics used for electrical and electronic equipment	Possible risk of harm to the unborn child	Halogenated Compounds of Aromatic Rings covered under Schedule 2 as A16  ≥0.005%
17	Polychlorobiphenyls : The level of 50 mg/kg (0.005%) should be the defining threshold concentration for wastes containing PCBs and PCTs: above that concentration such waste should be considered as hazardous.	PCBs were extensively used in electrical equipment such as capacitors and transformers. Small capacitors include motor start capacitors and ballast capacitors. Motor start capacitors are used with single phase motors to provide starting torque; these capacitors can be found also in household electrical appliances including refrigerators, cookers, washing machines, air-conditioners, dishwashers. Ballast capacitors are found within fluorescent, mercury, and sodium lighting fixtures, and neon lights; they weight up to 1.6 kg, of which 0.05 kg are PCBs (USEPA, 1987) <sup>33</sup> .	Very toxic to aquatic organisms and may cause long term effects in the aquatic environment	Halogenated Compounds of Aromatic Rings covered under Schedule 2 as A16  ≥0.005%
18	Polyvinyl chloride (PVC)		As with any material containing chlorine, potential for forming dioxins and furans in case of uncontrolled burning. Liberation of HCL gas during combustion. Recent health/ environmental concerns have been raised about some additives used in PVC processing i.e. <ul style="list-style-type: none"> <li>• Heavy metals used as stabilizers</li> </ul> Phthalate plasticizers, although these have been used for more than 40 years without any measurable impact on health and environment.	Halogenated Aliphatic Compounds covered under Schedule 2 as B11  ≥0.5%

S.No.	Name	Usage	Substance Risk	Regulatory requirements with threshold quantities
19	Refractory Ceramic Fibers: [Man-made vitreous (silicate) fibers with random orientation with alkaline oxide and alkali earth oxide (Na <sub>2</sub> O+K <sub>2</sub> O+CaO+MgO+BaO) content less or equal to 18 % by weight]		May cause cancer by inhalation.  Irritating to the skin	Not covered under schedule 1 and 2
20	Tetrabromobisphenol-A (TBBPA): TBBPA is the largest volume brominated flame retardant in production today. It is used as a reactive (primary use) or additive flame retardant in polymers, such as ABS, epoxy and polycarbonate resins, high impact polystyrene (HIPS), phenolic resins, adhesives and others. Its main use in E&E equipment is as a reactive flame retardant in printed writing boards.		<ul style="list-style-type: none"> <li>• Perception of potential to form brominated dioxins/furans in thermal processes.</li> <li>• Perception of potential for endocrine modulating effects (hormone disrupter).</li> <li>• The whole substances group of BFRs is listed in general on the Danish list of “unwanted substances”</li> </ul>	Halogenated Compounds of aromatic rings covered under Schedule 2 as A16  >=.005%

**Annexure - III****Average weight and composition of selected appliances (typical)**

<b>Appliances</b>	<b>Average weight (kg)</b>	<b>Fe % weight</b>	<b>Non Fe-metal % weight</b>	<b>Glass % weight</b>	<b>Plastic % weight</b>	<b>Electronic components % weight</b>	<b>Others % weight</b>
Refrigerators and freezers	48	64.4	6	1.4	13		15.1
Personal computer	29.6	53.3	8.4	15	23.3	17.3	0.7
TV sets	36.2	5.3	5.4	62	22.9	0.9	3.5

**Recoverable quantity of elements in a PC (typical)**

<b>Elements</b>	<b>Content (% of total weight)</b>	<b>Content (kg)</b>	<b>Recycling efficiency (%)</b>	<b>Recoverable weight of element (kg)</b>
Plastics	23	6.25	20%	1.25069408
Lead	6	1.71	5%	0.08566368
Aluminum	14	3.85	80%	3.08389248
Germanium	0.0016	0.00	0%	0
Gallium	0.0013	0.00	0%	0
Iron	20	5.57	80%	4.45453312
Tin	1	0.27	70%	0.19188512
Copper	7	1.88	90%	1.69614576
Barium	0.0315	0.01	0%	0
Nickel	0.8503	0.23	0%	0
Zinc	2	0.60	60%	0.35979072
Tantalum	0.0157	0.00	0%	0
Indium	0.0016	0.00	60%	0.00026112
Vanadium	0.0002	0.00	0%	0
Terbium	0	0.00	0%	0
Beryllium	0.0157	0.00	0%	0
Gold	0.0016	0.00	99%	0.000430848
Europium	0.0002	0.00	0%	0
Tritium	0.0157	0.00	0%	0
Ruthenium	0.0016	0.00	80%	0.00034816
Cobalt	0.0157	0.00	85%	0.00362984
Palladium	0.0003	0.00	95%	0.00007752
Manganese	0.0315	0.01	0%	0
Silver	0.0189	0.01	98%	0.005037984
Antimony	0.0094	0.00	0%	0
Bismuth	0.0063	0.00	0%	0
Chromium	0.0063	0.00	0%	0
Cadmium	0.0094	0.00	0%	0
Selenium	0.0016	0.00	70%	0.00030464
Niobium	0.0002	0.00	0%	0
Yttrium	0.0002	0.00	0%	0
Rhodium	0	0.00	50%	0
Mercury	0.0022	0.00	0%	0
Arsenic	0.0013	0.00	0%	0
Silica	24.8803	6.77	0%	0

**Recoverable quantity of elements in a TV (typical)**

<b>Elements</b>	<b>%</b>	<b>PPM</b>	<b>Recoverable Weight of element (kg)</b>
Aluminum	1.2		0.4344
Copper	3.4		1.2308
Lead	0.2		0.0724
Zinc	0.3		0.1086
Nickel	0.038		0.013756
Iron	12		4.344
Plastic	26		9.412
Glass	53		19.186
Silver		20	0.000724
Gold		10	0.000362

**Materials recovered from refrigerators (typical)**

<b>Material Type</b>	<b>%</b>
CFCs	0.20
Oil	0.32
Ferrous Metals	46.61
Non-Ferrous Metals	4.97
Plastics	13.84
Compressors	23.80
Cables/Plugs	0.55
Spent PurFoam	7.60
Glass	0.81
Mixed Waste	1.30
<b>Total</b>	<b>100.00</b>



## Comparison of thresholds

S.No	Name	Substance Risk	Threshold as per Indian Regulation		Threshold as followed in Europe
1.	Short Chain Chloro Paraffins, Alkanes, C <sub>10-13</sub>	Very toxic to aquatic organisms. It may cause long term effects in the aquatic environment.	>=0.5%	Covered under schedule 2 as B11 Halogenated Aliphatic Compounds	>=25%
2.	Antimony trioxide	Limited evidence of a carcinogenic effect	>=0.005%	Covered under Schedule 2 as A1 Antimony and antimony compounds	>=1%
3	Beryllium metal	Beryllium component scrap is classified as non-hazardous in the OECD, Basel and EU Waste Control Systems. However, it is recommended that beryllium metal components should be segregated from equipment at end-of-life and returned to the supplier for recycling. Very toxic by inhalation. It may cause cancer by inhalation.	>=0.005%	Covered under Schedule 2 as A3 Beryllium and cadmium compounds	>=0.1%
4	Beryllium oxide (Beryllia)	Very toxic by inhalation. It may cause cancer by inhalation	>=0.005%	Covered under Schedule 2 as A3 Beryllium and cadmium compounds	>=0.1%
5	Cadmium	Very toxic by inhalation. It may cause cancer.  Harmful to aquatic organisms	>=0.005%	Covered under Schedule 2 as A4 cadmium and Beryllium compounds	>=0.1% to 25% Depending on risk phrase or perception
6	Cadmium oxide	May cause cancer by inhalation.  Toxic by inhalation. Toxic if swallowed. Danger of serious damage to health by prolonged exposure  Harmful if swallowed	>=0.005%	Covered under Schedule 2 as A4 cadmium and Beryllium compounds	>=0.1% to 25% Depending on risk phrase or perception

7	Cadmium sulphide	Limited evidence of a carcinogenic effect  Toxic by inhalation. Toxic if swallowed. Danger of serious damage to health by prolonged exposure  Harmful if swallowed. It may cause long term effects in the aquatic environment.	$\geq 0.005\%$	Covered under Schedule 2 as A4 cadmium and Beryllium compounds	$\geq 1\%$ to 25% Depending on risk phrase or perception
8	Chromium VI	Toxic if swallowed/very very toxic by inhalation. It may cause heritable genetic damage. It may cause cancer by inhalation.  Very toxic to aquatic organisms and may cause long term effects in the aquatic environment.	$\geq 0.005\%$	Covered under Schedule 2 as A5 Chromium (VI) compounds	$\geq 0.1\%$ to 0.25% Depending on risk phrase or perception
9	Copper beryllium alloys	Components in end-of-life electrical equipment can be recycled as part of the general copper recycle stream. There is generally no need for component extraction prior to equipment recycling.  Toxic by inhalation	$\geq 0.005\%$	Covered under Schedule 2 as A3 Beryllium and Beryllium compounds	$\geq 0.1\%$ to 3% Depending on risk phrase or perception
10	Decabromodiphenylether (DBDE)	Potential for forming brominated dibenzodioxins or furans (PBDD/F) in uncontrolled thermal processes, and possibility that higher PBDEs could debrominate to form the tetra and penta BDEs found in marine environment food chain	$\geq 0.005\%$	Covered under Schedule 2 as A16 Halogenated Compounds of Aromatic Rings	Threshold is not mentioned as risk assessment studies are ongoing
11	Lead	Processing of metallic lead may give rise to lead compounds, which are all, classified as dangerous substances. The land filling of WEEE has given rise concerns over possible leaching of lead into the environment.	$\geq 0.5\%$	Schedule 2 as B4 Lead and Lead compounds	Threshold limit not mentioned
12	Lead oxide	May cause harm to the unborn child Harmful by inhalation/harmful if swallowed	$\geq 0.5\%$	Cover under Schedule 2 as B4 Lead and Lead compounds	$\geq 0.5\%$ to $\geq 25\%$

13	Liquid Crystals: Commercially available liquid crystals (LC) are mixtures of 10 to 20 substances, which belong to the group of substituted phenylcyclohexanes, alkylbenzenes and cyclohexylbenzenes. The chemical substances contain oxygen, fluorine, hydrogen and carbon. About 250 chemical substances are used for formulating more than thousand marketed liquid crystals.	Press articles claiming that LCDs contain carcinogenic azo-dyes. More current articles talk about hazardous ingredients. Toxicological studies on a large number of single liquid crystals have been performed according to OECD Guidelines and EU regulation. SO far no indications of carcinogenic potential and acute oral toxicity have been found.		Not covered under schedule 1 and 2	Threshold limit not mentioned
14	Mercury	Very toxic to aquatic organisms and may cause long term effects in the aquatic environment. Effects in humans are mainly affecting the central nervous system effects (CNS) as well as the kidney.  Toxic by inhalation	$\geq 0.005\%$	Cover under Schedule 2 as A6 Mercury and mercury compounds	$\geq 3\%$ to $\geq 0.25\%$
15	Mineral Wool: [Man-made vitreous (silicate) fibers with random orientation with alkaline oxide and alkali earth oxide (Na <sub>2</sub> O+K <sub>2</sub> O+CaO+MgO+BaO) content greater than 18 % by weight]	Limited evidence of carcinogenic effect  Irritating to the skin		Not covered under schedule 1 and 2	$\geq 1\%$ to $\geq 20\%$
16	Octabromodiphenyl ether (OBDE)	Possible risk of harm to the unborn child	$\geq 0.005\%$	Cover under Schedule 2 as A16 Halogenated Compounds of Aromatic Rings	$\geq 5\%$

17	Polychlorobiphenyls : The level of 50 mg/kg (0.005%) should be the defining threshold concentration for wastes containing PCBs and PCTs: above that concentration such waste should be considered as hazardous.	Very toxic to aquatic organisms and may cause long term effects in the aquatic environment	$\geq 0.005\%$	Cover under Schedule 2 as A16 Halogenated Compounds of Aromatic Rings	$\geq 0.25\%$
18	Polyvinyl chloride (PVC)	As with any material containing chlorine, potential for forming dioxins and furans in case of uncontrolled burning. Liberation of HCL gas during combustion. Recent health/environmental concerns have been raised about some additives used in PVC processing i.e. <ul style="list-style-type: none"> <li>• Heavy metals used as stabilizers</li> <li>• Phthalate plasticizers, although these have been used for more than 40 years without any measurable impact on health and environment.</li> </ul>	$\geq 0.5\%$	Cover under Schedule 2 as B11 Halogenated Aliphatic Compounds	
19	Refractory Ceramic Fibers: [Man-made vitreous (silicate) fibers with random orientation with alkaline oxide and alkali earth oxide ( $\text{Na}_2\text{O}+\text{K}_2\text{O}+\text{CaO}+\text{MgO}+\text{BaO}$ ) content less or equal to 18 % by weight]	May cause cancer by inhalation.  Irritating to the skin		Not covered under schedule 1 and 2	$\geq 0.1\%$ to $\geq 20\%$

20	<p>Tetrabromobisphenol-A (TBBPA): TBBPA is the largest volume brominated flame retardant in production today. It is used as a reactive (primary use) or additive flame retardant in polymers, such as ABS, epoxy and polycarbonate resins, high impact polystyrene (HIPS), phenolic resins, adhesives and others. Its main use in E&amp;E equipment is as a reactive flame retardant in printed writing boards.</p>	<ul style="list-style-type: none"> <li>• Perception of potential to form brominated dioxins/furans in thermal processes.</li> <li>• Perception of potential for endocrine modulating effects (hormone disrupter).</li> <li>• The whole substances group of BFRs is listed in general on the Danish list of “unwanted substances”</li> </ul>	>=.005%	<p>Cover under Schedule 2 as A16 Halogenated Compounds of aromatic rings,</p>	<p>Not mentioned</p>
----	---	---	---------	---	----------------------

E-waste trade value chain

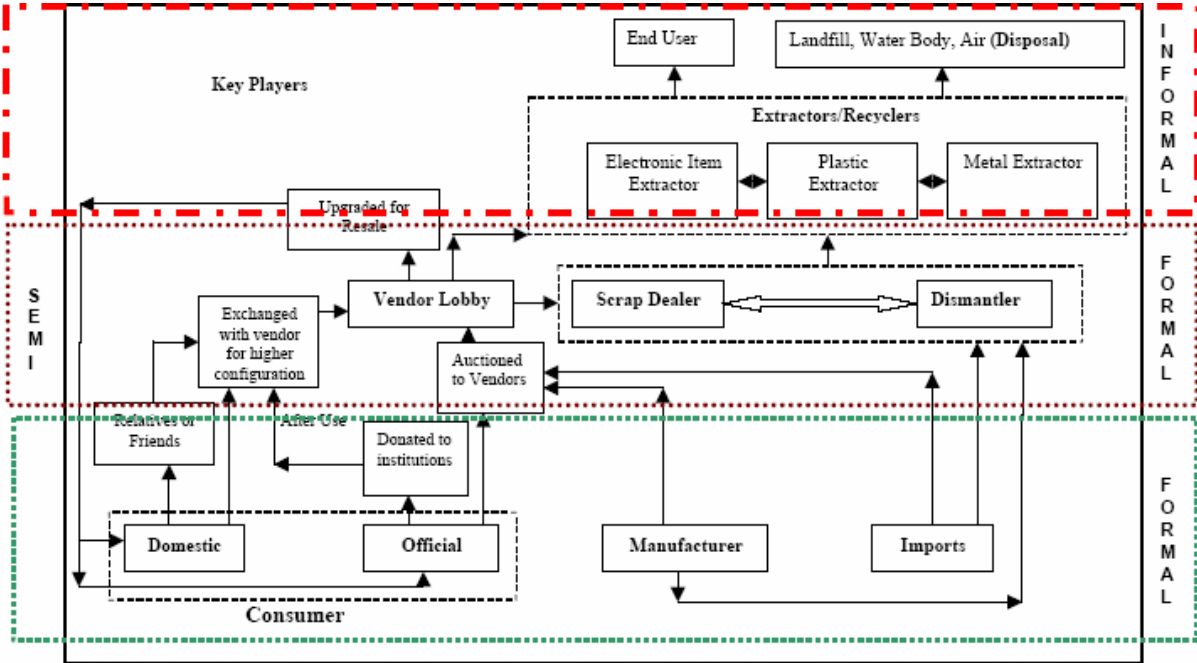

Source: Presentation of Delhi study, CPCB/ MoEF, March 2004

Environmentally Sound Treatment (EST) schemes for E-waste

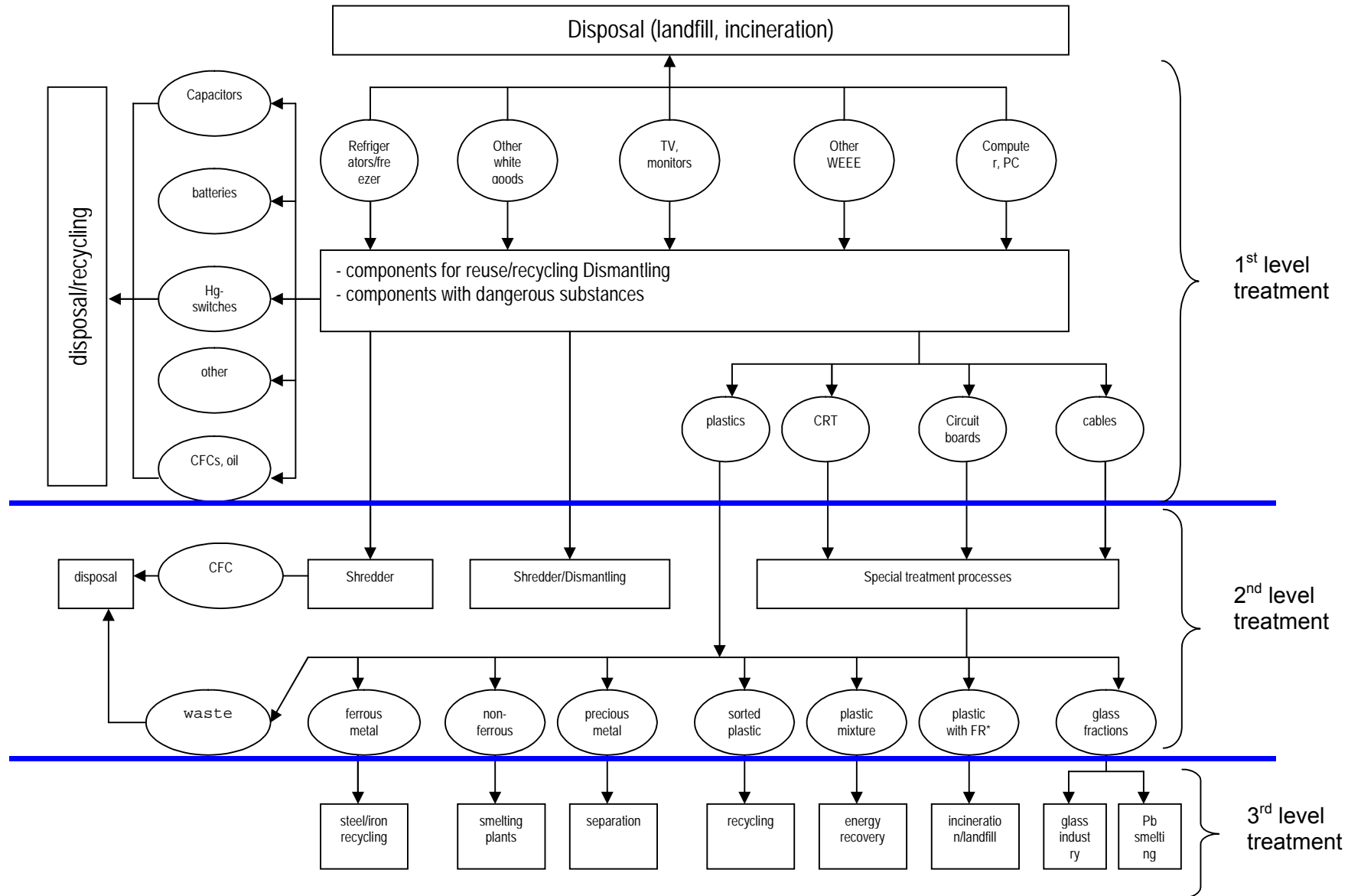

\* FR = flame retardant  
CFC = chlorofluorocarbon

## Annexure - X

Environmental impacts of the WEEE recycling system, i.e. collection, sorting and further treatment (dark bars), compared with the avoided environmental impacts of the WEEE incineration and the primary production of the raw materials (bright bars)

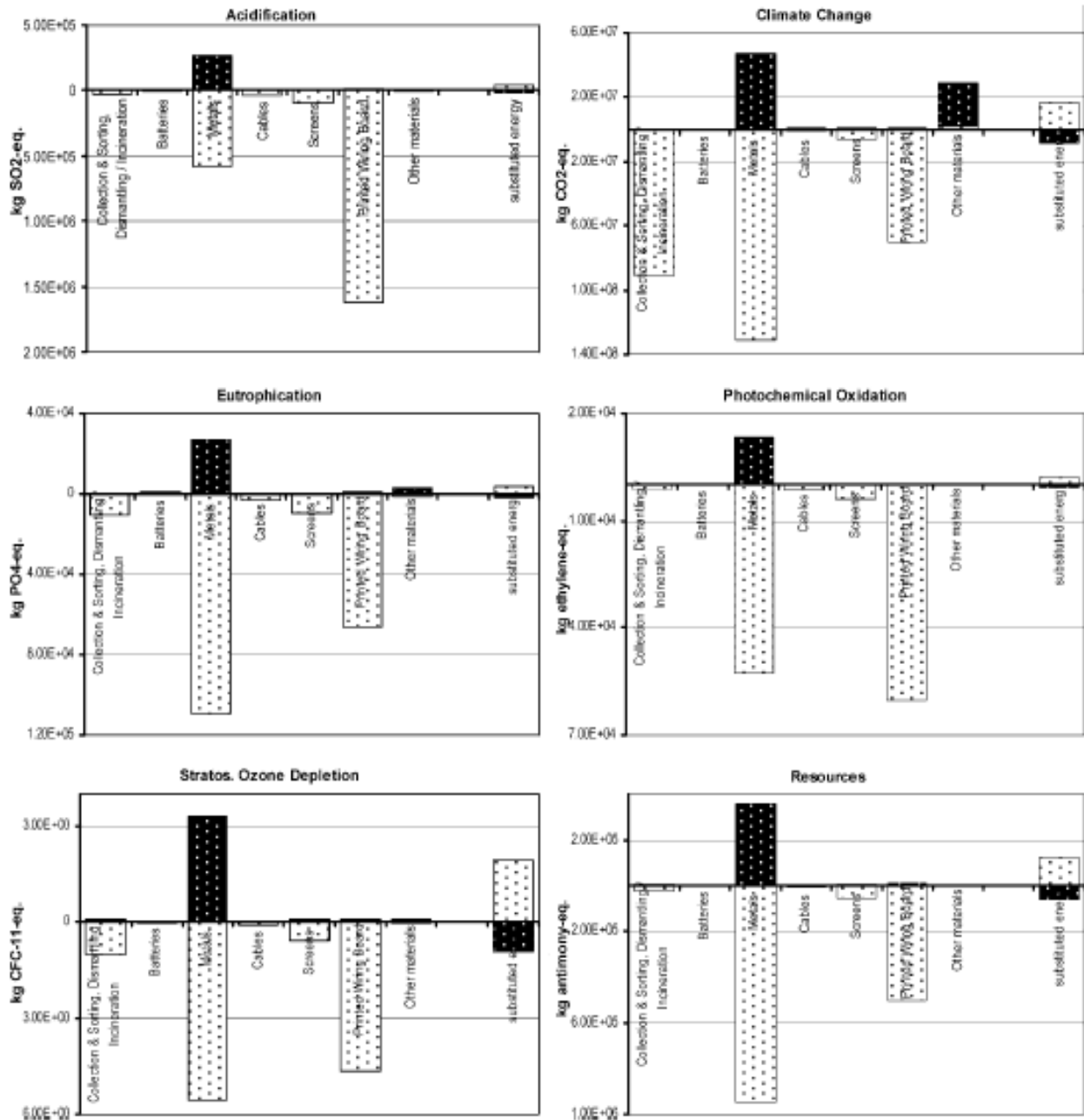

Source: R.Hishier et al. Does WEEE recycling make sense from an environmental perspective? The environmental impacts of the Swiss take-back and recycling systems for waste electrical and electronic equipment (WEEE), Environmental Impact Assessment Review 25 (2005) 525-539



## PROCESS FLOW DIAGRAM OF AN INTEGRATED FACILITY

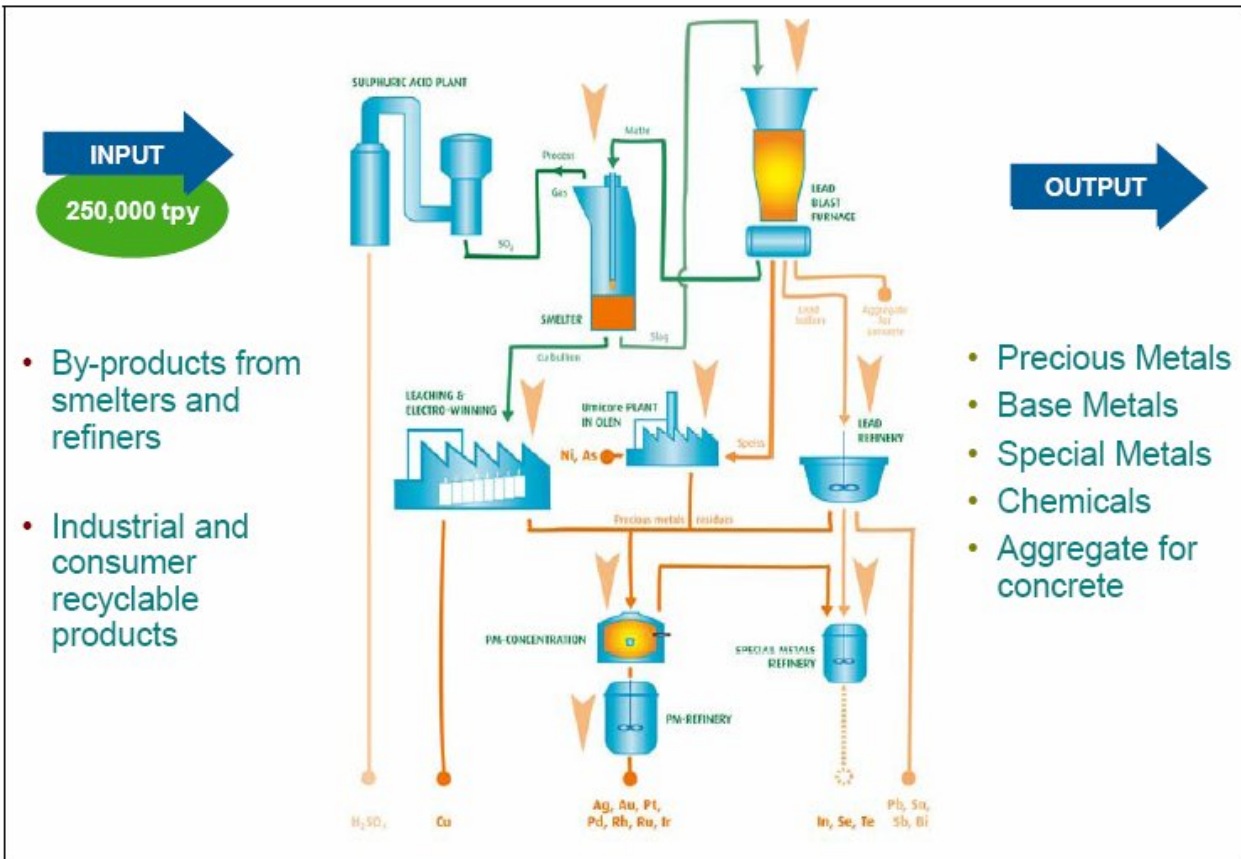

Source: Recycling of electronic scrap at Umicore's integrated metals smelter and refinery, Proceedings of EMC 2005

The salient features of this operation are given below.

1. The integrated operations are based on two major processes, which are precious metal operations (PMO) involving recovery of gold, silver, platinum, palladium, rhodium, iridium and ruthenium and base metal operations (BMO) involving recovery of Pb, Cu, Ni, Sb, Sn, Bi, Se, In, Te, As.
2. The processes are based on complex lead/ copper/ nickel metallurgy, using these base metals as collectors for precious metals and special metals, such as Sb, Bi, Sn, Se, Te, In.
3. At first at the sampling facility, circuit boards and other E-waste residues after second level of treatment are prepared for smelting by sampling and assaying for precious metal content.

- The PMO include smelter, copper leaching & electro winning plant and precious metals refinery. The smelter furnace uses submerged lance combustion technology as shown in figure given below. The technology involves injection of oxygen-enriched air and fuel in a molten bath and addition of coke as a reducing agent for the metals. Plastics or other organic substances that are contained in the input feed partially substitute the coke and fuel as energy source. The smelter separates precious metals in copper bullion from all other metals concentrated in a lead slag.

**Figure : Smelting and Electro winning during PMO in an integrated plant**

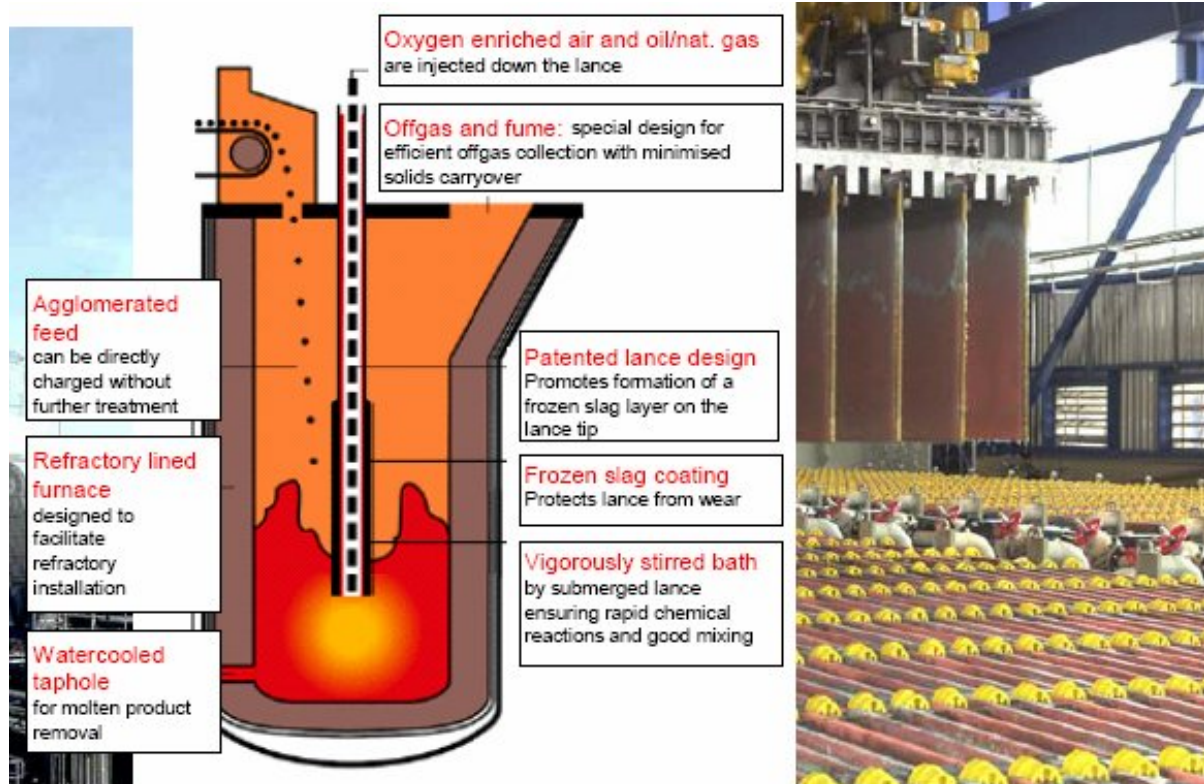

Source: Recycling of electronic scrap at Umicore's integrated metals smelter and refinery, Proceedings of EMC 2005

- After leaching out copper in leaching and copper electro winning plant, the precious metals are collected in a residue that is further refined at a precious metal in-house refinery.
- The BMO include lead recovery from lead slag obtained from PMO. The main steps in BMO are the lead blast furnace, lead refinery and special metal plants.
- The lead blast furnace reduces the oxidized lead slag from the smelter together with other high lead containing raw materials and transforms them into impure lead bullion, nickel speiss, copper matte and deleted slag.

8. The impure lead bullion, collecting most of the non-precious metals is treated in lead refinery. The lead refinery leads to production of lead and sodium antimonite and special metals residues. These residues are further refined into special metals refinery to produce indium, selenium and tellurium.
9. Bismuth and tin intermediates and nickel speiss are sent to other locations for their recovery. Copper matte is fed into blast furnace used in PMO.
10. The by-products from the integrated facility include sulfuric acid, gas, waste water and slag from lead blast furnace. Sulfuric acid is further used, while, waste water, gas are cleaned before discharge while slag is physically calibrated for usage in concrete industry or as dyke fortification substance.
11. Air is cleaned using bag house filter, electrofilters and scrubbers before discharging into stack.  $\text{SO}_2$  and  $\text{NO}_x$  are continuously monitored at stack, while diffuse emissions are from stockyards and roads are controlled by intensive sprinkling. Other measures to control air pollution include dust free emptying of shipped drums/ big bags, dust free sampling procedures, storage of critical materials in containers inside a warehouse, emptying of the containers under aspiration and transport in covered belt system.
12. Water pollution is controlled by using waste water treatment plant where acids are neutralized while metals, sulphates and fluorine are removed by physico-chemical processes. Some of the major parameters in addition to basic water quality parameters, which are monitored, are lead, zinc, copper, nitrates and nitrites and sulphates.

**REFERENCES :**

1. Compendium on National WEEE Legislation, United Nations University, United Nations Environment Program, 2006.
2. Implementation of the Waste Electrical and Electronic Equipment Directive in the EU, European Commission, Directorate General, Joint Research Centre, IPTS, 2006.
3. Information Technology (IT) and Telecommunication (Telecom) Waste in Canada – 2003, Final Draft, Updated, Environment Canada, 2003.
4. IRGSSA (2004) Management, handling and practices of E-waste recycling in Delhi. IRGSSA, India.
5. WEEE Directive (EU, 2002a).

**LIST OF WEBSITES :**

1. [www.usepa.gov/epaoswer/hazwaste/recycle/ecycling/index.htm](http://www.usepa.gov/epaoswer/hazwaste/recycle/ecycling/index.htm)
2. [www.defra.gov.uk/environment/waste/index.htm](http://www.defra.gov.uk/environment/waste/index.htm)
3. [www.ec.gc.ca](http://www.ec.gc.ca)
4. [www.environment.gov.au](http://www.environment.gov.au)
5. [http://ec.europa.eu/environment/waste/weee/index\\_en.htm](http://ec.europa.eu/environment/waste/weee/index_en.htm)
6. [www.ewasteguide.info](http://www.ewasteguide.info)
7. [www.basel.int](http://www.basel.int)
8. [www.unep.org](http://www.unep.org)
9. <http://www.unep.ch/ozone/index.shtml>
10. [www.cpcb.nic.in/Hazardous%20Waste/default\\_Hazardous\\_Waste.html](http://www.cpcb.nic.in/Hazardous%20Waste/default_Hazardous_Waste.html)
11. <http://www.basel.int/industry/mppiwp/guid-info/index.html>